

NEW YORK
STATE GEOLOGICAL
ASSOCIATION

TWENTY-NINTH ANNUAL MEETING
WELLSVILLE, N. Y. — MAY 9-12, 1957

GUIDEBOOK
FOR
GEOLOGY OF S.W. TIER
OIL AND GAS FIELDS
OIL REFINING
FIELD TRIPS

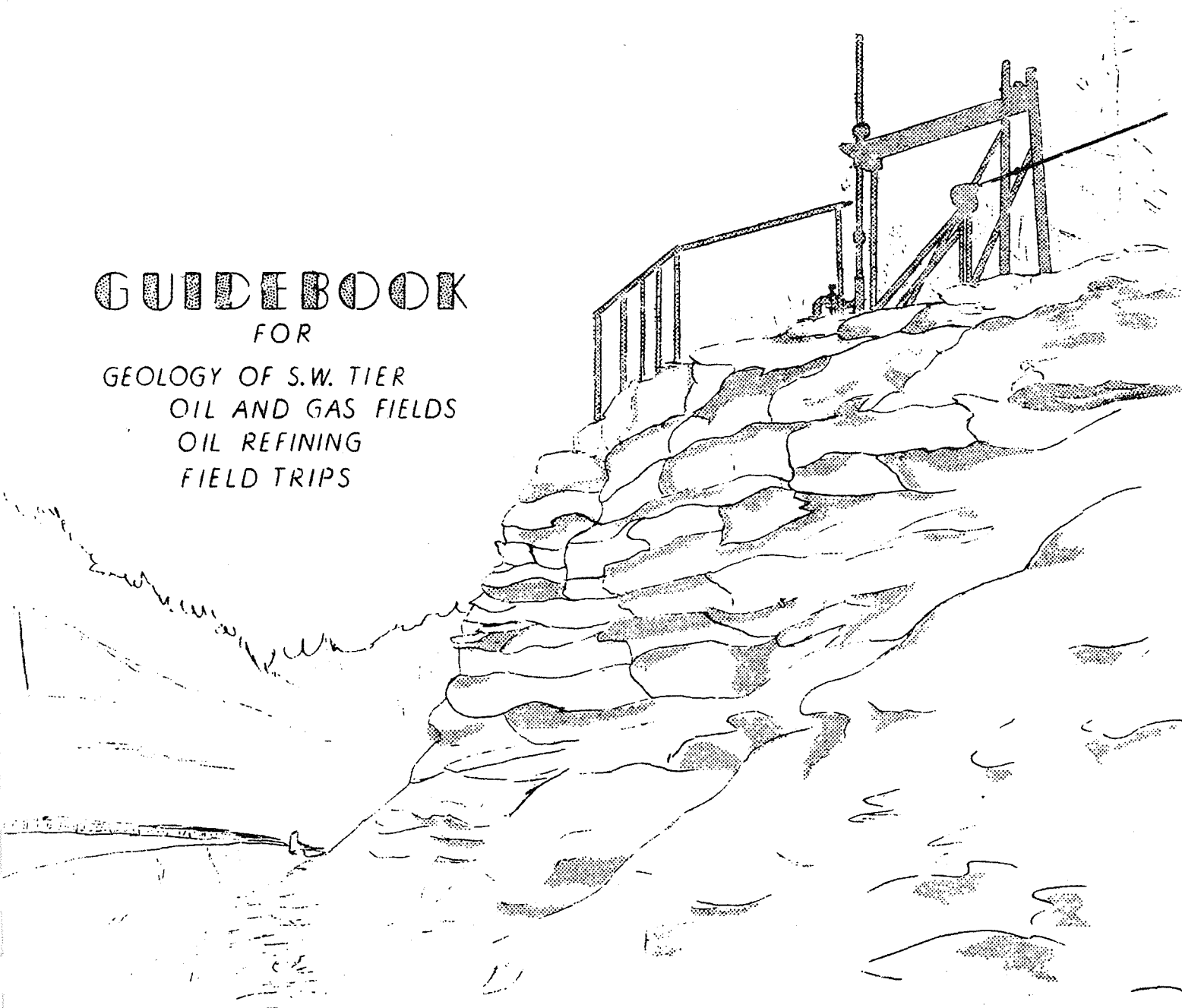

GUIDEBOOK

NEW YORK STATE GEOLOGICAL ASSOCIATION

Twenty-ninth Annual Meeting

Wellsville, New York

May 9-12, 1957

* * * * *

Prepared
by
Authors of the Various Chapters

Edited and Compiled
by
W. H. Young, Jr. and W. L. Kreidler

HOSTS

New York State Geological Survey
Sinclair Refining Co.
Oil and Gas Companies of the Area

* * * * *

Permanent Secretary for New York State Geological Association
Dr. Kurt E. Lowe
The City College, Dept. of Geology, 139th St. & Convent Ave., New York City 31, N.Y.

TABLE OF CONTENTS

	<u>Page</u>
List of Illustrations, Maps, Figures - - - - -	1
Schedule of Events - - - - -	2
I - Introduction- - - - -	3
II - Physiography and Glacial Geology- - - - -	5
III - Stratigraphy and Paleontology - - - - -	15
IV - Devonian Depositional History - - - - -	21
V - Relation of Oil and Gas Production to Structure - - - - -	27
VI - Sub-Oriskany Oil and Gas Possibilities- - - - -	30
VII - Underground Gas Storage - - - - -	32
VIII - Secondary Recovery of Oil by Waterflooding- - - - -	39
IX - Oil Refining- - - - -	50
X - Field Trip Logs	
Trip A1 - A2 - Geological Outcrops in the Wellsville Area-	54
Trip B1 - B2 - Harrison Valley Oriskany Gas Storage Field-	56
Trip C1 - C2 - Sinclair Oil Refinery - - - - -	No Log
Trip D - Oil Fields and Well Shooting- - - - -	58
Trip E - Stratigraphy of Southwestern New York - - -	61
XI - Acknowledgments - Hosts, Sponsors, Contributors - - - - -	64
XII - References and Topo Sheets- - - - -	65

ILLUSTRATIONS, MAPS, FIGURES

		Page
Map.1	Glacial Features of Allegany County and Vicinity - - - - -	4
Table 1	Geologic Exposures and Places of Historical Interest - - - - -	12
Map 2	Geological Map of Wellsville Area- - - - -	13
Table 2	General Stratigraphic Column - - - - -	17
Fig. 1	Upper Chemung and Lower Canadaway Stratigraphic Relationships- - - - -	16
Plate 1	Fossils Commonly Encountered in Wellsville Region- - - - -	22
Fig. 2	Upper Devonian Depositional Phases - - - - -	23
Table 3	Key to Oil and Gas Fields and Anticlines of Map 3- - - - -	24
Map 3	Structure Map of Wellsville Area with Oil and Gas Fields - - - - -	25
Chart 1	Sample Correlation Showing Approximate Positions of Oil Horizons - - -	28
Map 4	Structure of the Harrison Gas Field before Storage - - - - -	35
Fig. 3	Flow Diagram and Layout for Typical Waterflood Operation - - - - -	43
Fig. 4	Typical Separator as Used in Allegany Field- - - - -	46
Chart 2	Flow Chart for Processing Pennsylvania Grade Crude Oil- - - - -	51
Fig. 5	Layout of Harrison Valley Compressor Station - Trips B1 - B2 - - - - -	57
Fig. 6	Layout of Water Injection System - Trip D- - - - -	59
Fig. 7	Layout of Oil Well Power and Stock Tanks - Trip D- - - - -	60

SCHEDULE

Headquarters - Wellsville Rod & Gun Club, on Gypsy Lane about 1.5 miles SE of village.

Note: All trips will leave from headquarters in private cars. Come prepared to take or go with others, so all cars will be filled.

EMERGENCY CALLS from out of town can be directed to the Hotel Fassett - Tel. Wlsv. 744

Thursday May 9

3 P.M. TRIP C2 - Sinclair oil refinery (same as Trip C1). See questionnaire for name and address data.

7-11 P.M. Registration, exhibits, social evening at headquarters. Sleeping accommodations will be assigned upon registration. (These may be secured before 5 P.M. by calling Wellsville 492.

Friday, May 10

8 A.M.-1 P.M. Registration at headquarters. Secure location of accommodations here when registering.

ONE OR TWO TRIPS MAY BE SELECTED FOR THE MORNING.

8:30 A.M. TRIP A1 - Geological outcrops in Wellsville area. Visit and study the Wellsville, Machias, Cuba & Hinsdale (U. Dev.) units and fossil locations.

TRIP B1 - Harrison gas storage field. Visit an Oriskany sandstone gas field previously depleted and now used for storage of gas from Texas and the south.

TRIP C1 - Sinclair oil refinery. Trip through the Sinclair Refining Company's Wellsville plant which processes Allegheny crude oil.

Noon Lunch at headquarters - price ± 80¢

1 P.M. TRIP D - Oil fields and well shooting. See the secondary recovery of oil by waterflooding. Visit water treating and pressure plants; flowing and pumping oil wells; oil, gas & water separators; see a well "shot" with nitroglycerine.

6:30 P.M. Annual banquet at High School cafeteria. Field clothes will be permitted. Dinner will be served semi-cafeteria style. Price \$2.00 including tip. Short business meeting will be followed by a panel discussion and question period on the subjects covered on all field trips.

Saturday, May 11

7:30 A.M. Registration for late comers

8:00 A.M. TRIP E - Stratigraphy and glacial geology of southwestern N.Y. This will include stops at the Wolf Creek conglomerate (U.Dev.) fossil locale and the Olean conglomerate (Penn.) outcrop at Rock City.

Noon Lunch (price ± 80¢) and exploration of the famous Olean conglomerate "boulder city".

Sunday, May 12

8:30 TRIP A2 - Geological outcrops in Wellsville area. (same as Trip A1).

TRIP B2 - Harrison gas storage field. (same as Trip B1).

I - INTRODUCTION

Wellsville, the headquarters of this twenty-ninth annual meeting of the New York State Geological Association, shares with Bolivar and Olean the privilege of being the oil center of New York State.

Both Wellsville and Bolivar mark the northern edge of the Allegheny Oil Field, whose various oil pools extend both east and west of these villages and south to the state line and across into Pennsylvania a short distance to Shinglehouse. Associated with these stratigraphic type oil pools are similarly trapped areas of gas production, all found within 300'-500' of vertical section of Upper Devonian strata. In close geographic association are also found several structurally controlled Oriskany sand (Lower Devonian) gas fields.

Olean, about 35 miles west of Wellsville, marks the northeastern edge of the oil production which extends northward into New York State from the huge Bradford Oil Field in Pennsylvania. Here we also find numerous oil pools producing from stratigraphic traps in approximately the same 500' section of Upper Devonian strata.

The geology of this area has been closely linked with this oil and gas production and consequently most of the total geologic study time spent in the area has heretofore been confined to the subsurface structure and correlation of these oil and gas producing horizons in the never-ending search for more oil or gas. Within the last 15 years more study has been devoted by various geologists to the more complete understanding of the stratigraphic complexities of the Upper Devonian surface outcrops.

To these and to the methods and processes of oil and gas production and refining this meeting is completely dedicated.

GLACIAL FEATURES OF ALLEGANY COUNTY AND VICINITY

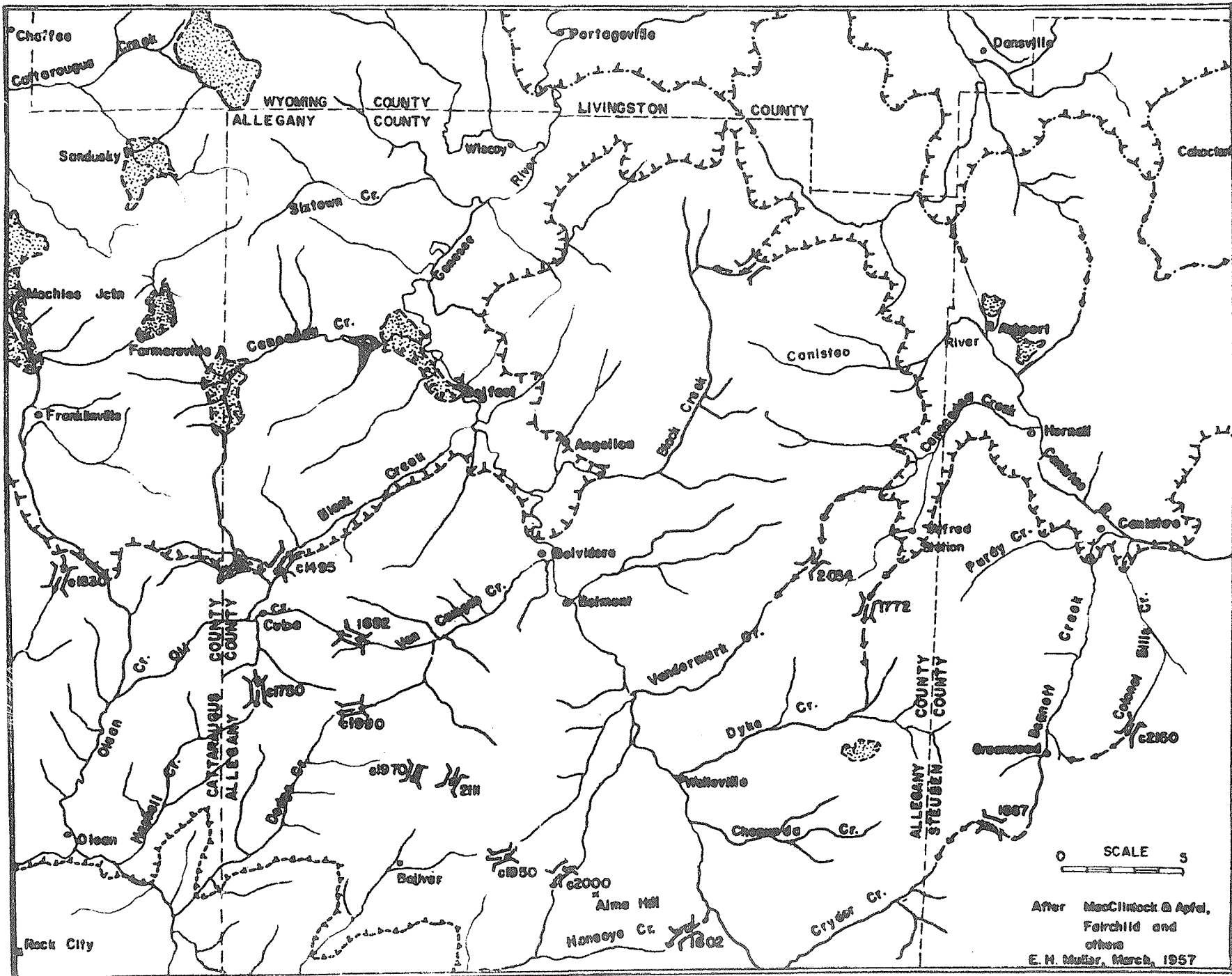

After MacClintock & Apfel,
Fairchild and
others
E. H. Muller, March, 1957

HYPOTHETICAL DRIFT BORDERS VALLEY MEANDERS BRIGHTON MORAINES OLEAN MORAINES MELTWATER CHANNELS
AREAS OF STAGNANT ICE DEPOSITS

II - PHYSIOGRAPHY AND GLACIAL GEOLOGY OF ALLEGANY COUNTY AND VICINITY

by Ernest H. Muller - Cornell University

INTRODUCTION

In the text to follow, the location of many geographic features is indicated in parenthesis. The parenthetical enclosure names the topographic sheet and the portion of that sheet, divided into ninths by parallels and meridians at 5 minute intervals, on which the feature can be found. The nine sections of each map are indicated by letters as shown at the right:

NW	N	NE
W	C	E
SW	S	SE

PHYSIOGRAPHY

The field area is part of the Appalachian Plateau province, a mature, medium textured upland of moderate relief developed on sedimentary rocks with small southward regional dip. Most of the area bears the imprint of moderate glaciation during two or more episodes of the Pleistocene Epoch and for this reason belongs to the Southern New York section of the Appalachian Plateau. In the southwest corner of the field area a portion of Cattaraugus County is part of the Salamanca re-entrant, the northernmost area in eastern United States to escape glaciation. As such it lacks the characteristic open valleys, glacially scoured summits and drift deposits of the Southern New York section. Instead the landscapes of the Salamanca re-entrant are shaped primarily by normal processes of mass wasting and stream erosion and therefore belong to the unglaciated Kanawha section of the Appalachian Plateau.

The field area includes the most rugged topography in western New York. Maximum relief is more than 1400 feet and local relief of 600 to 800 feet is rather general along the south border. Alma Hill (Belmont, SE), with summit elevation of 2548 feet above sea level, is the highest point in New York west of the Catskill plateau. The lowest elevation in Allegany County is below 1120 feet where the Genesee River crosses into Wyoming County northeast of Wiscoy (Portage, SE). Local relief decreases generally northward but even near the Wyoming county line is commonly more than 500 feet.

The major drainage divide between watersheds of the Atlantic Ocean and the Gulf of Mexico passes northwest across Allegany and Cattaraugus Counties. Most of the field area lies within the drainage basin of the Genesee River, the only river which flows across New York state. With headwaters across the state line in Pennsylvania, the Genesee flows northward into Lake Ontario near Rochester, and so is tributary to the St. Lawrence River. Northeastern Allegany County and adjacent parts of Steuben County lie in the watershed of the Canisteo River which is tributary to the Chemung and thus also to the Susquehanna. A small portion of southwestern Allegany County and adjacent Cattaraugus County lie west of the major divide so that runoff in these areas ultimately reaches the Gulf of Mexico by way of the Allegheny, Ohio and Mississippi Rivers.

INFLUENCE OF ROCK STRUCTURE ON TOPOGRAPHY

The structure of underlying Paleozoic sedimentary rocks plays a subordinate role in topographic development except southwest of the Allegheny River. The stratigraphic section which is exposed at the surface or concealed beneath the drift mantle consists of interbedded shale and sandstone with a number of locally conspicuous conglomerate layers in the upper part of the column. The rocks are of Upper Devonian age and are

progressively younger southward to the state line near which are scattered remnants of Pennsylvanian conglomerate. Although the regional dip is southward at a fraction of a degree, the strata are warped into shallow open folds which trend northeastward and cause local variation and reversal of dip.

In a general way, the stream pattern of the southern portion of the Wellsville and Belmont quadrangles reflects the influence of structure. Beech Hill (Wellsville, S and SE) lies along the trend of the Sharon-Watkins anticline, one of the few structures with significant closure. Honeoye (Wellsville, SW) and Cryder Creeks (Wellsville, S & SE) parallel the limbs of the fold and their valley walls are asymmetrically developed, being perceptibly steeper downdip.

Woodruff (1942, p. 97) related the slight southward slope of many flat-topped summit remnants in the vicinity of Wellsville to regional dip on resistant capping strata.

The bench-forming tendencies of the more resistant strata are evident in parts of the unglaciated area west of the Allegheny River. Whereas dominantly shaly sections tend to develop gentle slopes because of their lack of resistance to erosion, the massive and resistant beds support subdued scarplets. A typical situation involves marked steepening over sandy strata near the top of the Chadakoin group beneath a gentle slope developed on Cattaraugus shale. The Salamanca conglomerate in places supports distinct benches, and higher in the section, the Knapp and Olean conglomerates cap local plateau remnants.

Picturesque features of the Appalachian Plateau are the "rock cities" produced by weathering of exposed scarplets capped by strata such as the Salamanca, Knapp and Olean conglomerates. Conditions favorable for the development of rock cities include massive bedding, widely spaced jointing, high permeability and resistance to weathering in the capping layer, and the presence of an underlying shale. Although the most striking "rock cities" are in unglaciated portions of the plateau, others have apparently developed within the past 13,000 years. Weathering along joint planes permits downward movement of ground water which percolates along bedding planes. In time basal sapping produces a low slope and aided by processes of mass wasting widens the joint planes into narrow angular passageways reminiscent of city streets between high-walled buildings. Progressive weathering causes rounding and decrease in average size of the boulders which have been longest in transit and have moved farthest downslope from the ledge. Frost processes more intense than at present may have played a role in development of some "rock cities".

PRE-GLACIAL EROSIONAL HISTORY

Of the long and probably complex erosional history which followed uplift of the Paleozoic strata above sea level only incomplete evidence remains. It is commonly assumed that uplift took place in a succession of pulses before and during the Appalachian orogeny which brought the Paleozoic Era to a close. By virtue of its position northwest of the axis of major deformation, the region of Allegany County probably developed drainage north or northwest. In course of time the region was reduced nearly to base level with development of a peneplain which has been variously referred to as the Schooley, Kittatinny and Upland peneplain (Cole, 1938, p. 196). Lack of pre-Pleistocene deposits preserved on the upland surface makes precise dating impossible. Estimates of the interval since peneplanation are based on evaluation of the time required for subsequent renewed uplift, dissection and slight reduction of the surface. Such estimates range from Cretaceous to Miocene, with recent consensus probably favoring the later date and shorter interval since peneplanation.

In Allegany County the Upland peneplain is represented by closely accordant summit levels. Reconstruction of the peneplain on the basis of present summit elevations shows a surface of low relief which bevels structure, exposing progressively older beds

northward. The close conformity of summit level within the glacial border and in the Salamanca re-entrant shows that glaciation exerted a very subordinate effect in reducing the upland remnants in southwestern New York. Regional slope on the reconstructed surface is north, west and east from the highest region in southern Allegany County, at gradients of several tens of feet per mile (Woodruff, 1942, p. 94-97). This slope may reflect either initial relief, subsequent slight warping of the peneplain, or differential reduction of summits on strata of dissimilar erosional resistance.

Subsequent rejuvenation of the peneplain probably took place unevenly with intermittent uplift interrupted by intervals of stability with initiation of one or more intermediate erosion cycles represented by intermediate summit levels and straths described elsewhere in the Appalachian Plateau (Cole, 1938, p. 196).

The Tertiary peneplain presumably was covered by a residual soil mantle 10 to 30 feet thick prior to uplift. Reduction of the upland surface since rejuvenation has removed all trace of any such paleosol even in the unglaciated portions of the plateau. How much additional denudation may have occurred is difficult to estimate. Woodruff (1942, p. 97) suggests that summits in the eastern part of Greenwood quadrangle occur at intermediate elevations because they are developed on shale whereas higher summits to the west are capped by coarser and thicker units. In Potter County just across the state line from southern Allegany County, Denny (1956b, p. 49) shows that the upland surface reflects differential erosional resistance of bedrock and infers that average reduction of upland remnants by 75 to 100 feet has taken place within the Pleistocene Epoch.

Northwestward migration of drainage divides may have brought north central Pennsylvania into the watershed of the ancestral Susquehanna before the onset of Pleistocene glaciation, but preglacial drainage in New York is commonly conceived as being northward by the ancestral Genesee and Allegheny Rivers into a hypothetical "Ontarian River" along the axis of present Lake Ontario. The mature valley of the Genesee upstream from Portageville is considered to mark a part of the preglacial course of this river, but the valley from Portageville to Canaseraga Creek has been cut as a result of late glacial diversion. The Allegheny River likewise follows its preglacial course in the field area but westward the ancestral valley is blocked and deeply filled with glacial debris where formerly the river flowed north past Randolph and Gowanda.

PRE-WISCONSIN GLACIAL HISTORY

The maximum extent of glaciation coincides closely with the Allegheny River in the field area, but there is evidence of at least one temporary blockage of the river by ice prior to the Wisconsin stage. Marginal drainage channels near Quaker Bridge in western Cattaraugus County indicate that the glacier at one time extended across the Allegheny valley and against the unglaciated upland to the east at an elevation of at least 1570 feet. Kame deposits one mile east of the confluence of Oswayo Creek with the Allegheny River have been interpreted as indicative of ice marginal deposition into a proglacial lake impounded in the upper Allegheny valley (Bryant, 1955, p. 65).

High gravel terrace remnants in the Allegheny valley are ascribed to pro-glacial deposition in Illinoian time on the basis of depth of leaching, intensity of weathering and height above the present flood plain. One of the largest of these remnants occurs two miles west of Olean and stands nearly 100 feet above the present flood plain. Till of probable Illinoian age is described in Woodchuck Hollow, 3 miles north of Olean, as containing a larger proportion of carbonate and igneous pebbles than are found in the overlying Olean drift (MacClintock and Apfel, 1944, p. 1147). The plausibility of this correlation is confirmed by radiocarbon dating of wood overlying similar weathered till at Otto, about 28 miles northwest of Olean. Because the wood is of age greater than 35000 years, the interval of weathering is inferred to represent the Sangamon interglacial stage and the underlying till is therefore Illinoian (Suess, 1954).

EARLY WISCONSIN GLACIAL HISTORY

Following the Sangamon interglacial stage which was milder and of longer duration than post-glacial time, Wisconsin ice spread southwest across the field area, reaching its terminal position in southwestern Allegany County and Central Cattaraugus County. The Wisconsin drift border is highly irregular and conforms to bedrock topography. Favored by the trend of Oil and Olean Creeks (Olean, N.), a large ice tongue spread into the Allegheny Valley to a point 4 or 5 miles west of Olean. This ice tongue overrode Illinoian terrace gravels and impounded a shallow body of water in the upper Allegheny valley. The Camel Back (Olean, SW) owes its notched profile to the dumping of lateral moraine against a bedrock knoll cut off from the spur to the south by a conspicuous marginal drainage channel.

Smaller ice tongues extended southwest in the valley of Dodge Creek as far as Portville, and in the valley of the Little Genesee River as far as Ceres where the end moraine is well developed. Near South Bolivar the Wisconsin drift border passes across the state line into Pennsylvania, angling southeast toward Williamsport.

Differentiation of Wisconsin drift sheets in the Appalachian Plateau have been based primarily on differences in pebble lithology, on variations in the depth of leaching of calcareous material, and under favorable conditions on continuous tracing of ice marginal deposits and features. The early Wisconsin or Olean drift (MacClintock and Apfel, 1944, p. 1153) has a pebble lithology composed essentially of the sandstone, siltstone and shale of the Devonian bedrock which underlies the plateau. Only two to five per cent each of carbonate and crystalline pebbles typically occur in the Olean drift, but in this latter far-traveled fraction occur cobbles apparently derived from the Champlain trough east of the Adirondacks, indicating ice movement from the northeast. Leaching to a depth of 10 feet or more is characteristic of Olean gravels. The drift sheet is generally thin and can be traced only with difficulty where it crosses uplands between valleys aligned in the direction of dominant ice movement.

The waning Olean ice sheet is presumed to have receded unevenly across the deeply dissected topography of southern and central Allegany County. Active ice movement probably persisted in valleys oriented in the direction of regional ice movement after the thinning ice became stagnant on the uplands or where it was cut off from its supply by an obstructing ridge. In the through valleys, ice retreat was by backwasting which resulted in marginal deposition at successive positions along the valley edge. Kame terraces deposited in this manner by the retreating Olean ice sheet occur from the Pennsylvania border north to Belvidere (Angelica, SE) along the Genesee Valley. Over the uplands, on the other hand, ice wastage was largely by downmelting with dead ice persisting in suitable locations even after bare ridges were exposed to the north. An area of kames and kettles deposited as the result of such a situation is located at an altitude of 2200 feet above sea level, $1\frac{1}{2}$ miles south of Andover (Wellsville, E) (See also Map 1).

During wastage of the Olean ice sheet meltwater streams cut notches as much as several hundred feet deep across the divide between the Genesee and Allegheny watersheds. Some of these notches were cut by streams flowing along the ice margin whereas others were outlets for short-lived lakes impounded in front of the ice in northward opening valleys. A number of the more deeply cut notches afford natural passes followed by highways and a railroad as listed below:

<u>Name and Location of notch</u>	<u>Divide Elevation</u>
Notch 4 miles south of Cuba (Olean, NE)	c. 1750 ft.
North at Borden (Belmont, NW)	1692 ft.
Clarksville Notch (Belmont, W)	c. 1990 ft.
West Notch (Belmont, C)	c. 1970 ft.

East Notch (Belmont, C)	2111 ft.
Notch at Vosburg on Route 17 (Belmont, S)	c. 1950 ft.
Notch north of Pikeville (Belmont, SE)	c. 2000 ft.

Honeoye and Cryder Creeks occupy deep and open valleys obviously inherited from streams more competent than exist there today. The valley of Cryder Creek is narrow and deep, but flat-bottomed and marshy right across the divide at 1867 feet above sea level (Greenwood, W and SW) into the present watershed of Bennett Creek. Across this col flowed the glacial waters impounded south of the ice front in the valleys of both Bennett Creek and Colonel Bills Creek. Joining the waters of proglacial Lake Wellsville in the upper Genesee Valley this drainage crossed the divide into the Allegheny watershed, cutting the open, flatbottomed col at 1602 feet above sea level at the head of Honeoye Creek (Wellsville, SW).

The Olean substage of the Wisconsin has been tentatively correlated with the Tazewell of the Mississippi basin (MacClintock, 1954) and referred to an Iowan-Tazewell complex (Flint, 1954). In the light of present radiocarbon data it seems probable that the interval was no more than a few thousand years between recession of the Olean ice sheet and renewal of glaciation during the subsequent substage.

LATE WISCONSIN GLACIAL HISTORY

Readvance of the ice sheet in late Wisconsin time was from a direction more nearly north than northeast, reflecting probably a shift in the conformation of domes of maximum ice accumulation. Erratic cobbles are "common to the Grenville province of Ontario and the western Adirondacks" (MacClintock and Apfel, 1944, p. 1156). By contrast to the underlying Olean till the late Wisconsin gravels and till are bright and clean-looking because of their higher content of carbonate and crystalline pebbles and lower proportion of drab and brown "plateau rock". A representative sample of this drift contains 5 to 12% of igneous and metamorphic pebbles and 12 to 25% of carbonate pebbles. The name Binghamton drift was given this material in Cattaraugus County and mapped in reconnaissance across Allegany, Steuben and adjacent counties by MacClintock and Apfel (1944, p. 1156).

The Binghamton drift border lies along a line from Ischua to Cuba Lake, thence eastward along the south wall of the valley of Black Creek (Angelica, SW and S) to the Genesee Valley where an ice tongue extended south to Belvidere (Angelica, S). From Belvidere northward the border lies along the east side of the Genesee Valley, projecting eastward into tributary valleys and passing from the northeast corner of the Angelica quadrangle onto the southwest corner of the Nunda sheet. Breasting the upland at 1900 feet south of Dalton (Nunda, SW) the moraine curves southeastward past Swain and Canaseraga (Canaseraga, NE). Thence, south past North Almond to Alfred Station (Canaseraga, SE) and Canisteo (Hornell, S) the border lies along the southwest wall of Canisteo Valley projecting southward up valleys of right bank tributaries.

Topographically, the Binghamton drift border is marked by massive kames and valley-stopper moraines with sharp unmodified relief in contrast to the rounded expression of older drift deposits. A typical association of such kettles and kames can be seen near Alfred Station (Canaseraga, SE). A well developed valley-stopper moraine occurs 4 miles west-southwest of Canaseraga where deposition of the associated outwash plain built up a flat, swampy valley bottom and shifted the Black Creek-Canaseraga Creek drainage divide several miles to the northeast (Canaseraga, N). Proglacial streams of short duration notched the divide to produce cols followed by present highways at Tip Top (1772 feet above sea level, Wellsville, NE), and Five Corners (2034 feet above sea level, Canaseraga, SE). Glacial meltwaters from all Allegany County reached the Allegheny River via the Honeoye channel (Wellsville, SW) briefly re-establishing Lake Wellsville, a lake about 15 miles long in the upper Genesee Valley.

Halfway between Almond and Hornell (Hornell, W) Canacadea Creek is diverted from a broad but partly drift-filled valley trending northeast into a narrower southeast trending bedrock valley. A sag which extends about 2 miles southwest from Webbs (Hornell, W) is the drift-obstructed extension of the interglacial valley of Canacadea Creek. Inasmuch as Binghamton till occurs at creek level two miles northwest of Hornell, stream diversion must have taken place prior to the Binghamton advance.

Although he recognized the possibility of alternative correlations, MacClintock (1954) considered the Binghamton moraine to be of Early Cary age. Recent radiocarbon dating of marl and basal peat from a depression marginal to the Binghamton moraine at Corry in Erie County, Pennsylvania appears to substantiate this correlation. Dates on marl and peat deposited following recession of Binghamton ice from its terminal position range between 13,000 and 13,900 years ago, corresponding to the end of the Early Cary in the Mississippi Valley type area (G. W. White and John Droste, personal communication).

Stagnant ice deposits marking progressive withdrawal of the ice border are distributed northward from Belfast (Angelica, C) along the Genesee Valley. A significant stillstand during the Binghamton recession is marked by massive and extensive valley-choking kame complexes such as those at Machias (Franklinville, NW), Sandusky (Franklinville, N) and Hardy's Corners (Franklinville, E) (Also see Map 1). Northward withdrawal of the ice margin from the valley of Black Creek exposed the low divide east of Cuba Lake (Franklinville, SE). Opening of this outlet for proglacial waters impounded in the upper Genesee valley resulted in abandonment of the Honeoye outlet channel and initiated Lake Belfast-Fillmore controlled by Cuba outlet at present elevation of 1496 feet above sea level.

In central New York east of the Genesee River the divide between the Susquehanna and St. Lawrence watersheds is generally determined by massive moraines of the Valley Heads system. During this glacial episode the ice terminus in the Genesee Valley stood at Portageville (Portage, SE), re-instating Lake Belfast-Fillmore by blocking outflow to the east past Dalton (Nunda, SW). The age of the Valley Heads moraine is established as Late Cary by radiocarbon dating of wood deposited on the outwash plain at Chaffee in the southeastern corner of Erie County, New York. Occurring at the base of a marly silt overlying outwash gravel, and dated at $12,020 \pm 300$ years the wood should closely postdate the maximum extent of Valley Heads ice (Meyer Rubin, personal communication).

Withdrawal of ice from the Valley Heads terminal moraine exposed very short-lived outlets at Dalton (Nunda, SW) and subsequently at Burns (Hornell, NW). Briefly, during the effective lives of these outlets proglacial Portgage Lake and Lake Dansville, respectively, extended up the Genesee Valley into northern Allegany County. Exposure of lower outlets westward past Batavia into the watershed of Lake Chicago terminated pro-glacial lake history in Allegany County.

TABLE 1 - GEOLOGICAL EXPOSURES IN THE WELLSVILLE AREA

- Sta. 1. Type locality of Wellsville member north of Wellsville, N. Y.
 Sta. 2. Hinsdale with some Wellsville at base of outcrop in road cut along Fords Brook.
 Sta. 3. Cuba with Machias at base of outcrop in road cut east of Scio along Vandermark Creek.
 Sta. 4. Machias in road cut on Route 36 between Andover and Alfred Station, New York.
 Sta. 5. Germania topping hills between Andover and Whitesville, New York
 Sta. 6. Dunkirk exposed in abandoned quarry north of Hornell with Wiscoy exposed below Dunkirk.
 Sta. 7. Reverse fault in Purdy Creek.
 Sta. 8. Type locality for Whitesville.
 Sta. 9-10. Probable Whitesville on Route 17 between Wellsville and Bolivar, New York.
 Sta. 11. Wolf Creek conglomerate in quarry south of Cuba and north of Portville, N.Y.
 Sta. 12. Type locality of Wolf Creek conglomerate north of Number 11.
 Sta. 13. Olean conglomerate an oil lease north of Little Genesee, New York.
 Sta. 14. Glacial exposure in cut along Erie railroad between Olean and Portville, N.Y.
 Sta. 15. Cattaraugus red beds and Oswayo exposed in road cut one mile south of New York-Pennsylvania state line on Pennsylvania Route 646.
 Sta. 16. Type locality of Olean conglomerate at Rock City, New York.
 Sta. 17. Binghamton glacial moraine at Alfred Station.
 Sta. 18. Rushford.

PLACES OF HISTORICAL OIL AND GAS INTEREST IN THE WELLSVILLE AREA
(From Kreidler, 1953)

1. 1627 The Cuba or Seneca Oil Spring, near Cuba, New York has generally been credited by early historians as being this original occurrence of petroleum. Father de la Roche de Allion, a Franciscan missionary, in a letter dated July 18, 1627, was the first to mention the occurrence of petroleum on the North American continent. In 1857 the first test well specifically drilled for oil on the North American continent was near the spring. It was drilled to a depth of 600 feet but did not prove to be commercially productive.
11. 1865 In New York just west of Limestone, oil was found at a depth of 1060 feet in the Bradford third sand.
111. 1879 The Triangle No. 1 well, the discovery well of the Allegheny field, was drilled by O. P. Taylor. The top of the 27-foot oil sand was found at 1126 feet and the well was drilled to 1177 feet.
- IV. 1928 Gilbert No. 1 well produced gas from the Tully limestone or top of the Hamilton. This well started a deeper exploration drilling program in the southern and southwestern counties of New York and north-central Pennsylvania which led to the discovery of the Oriskany sandstone gas fields of that area. After depletion of this gas well, it was made a storage well.

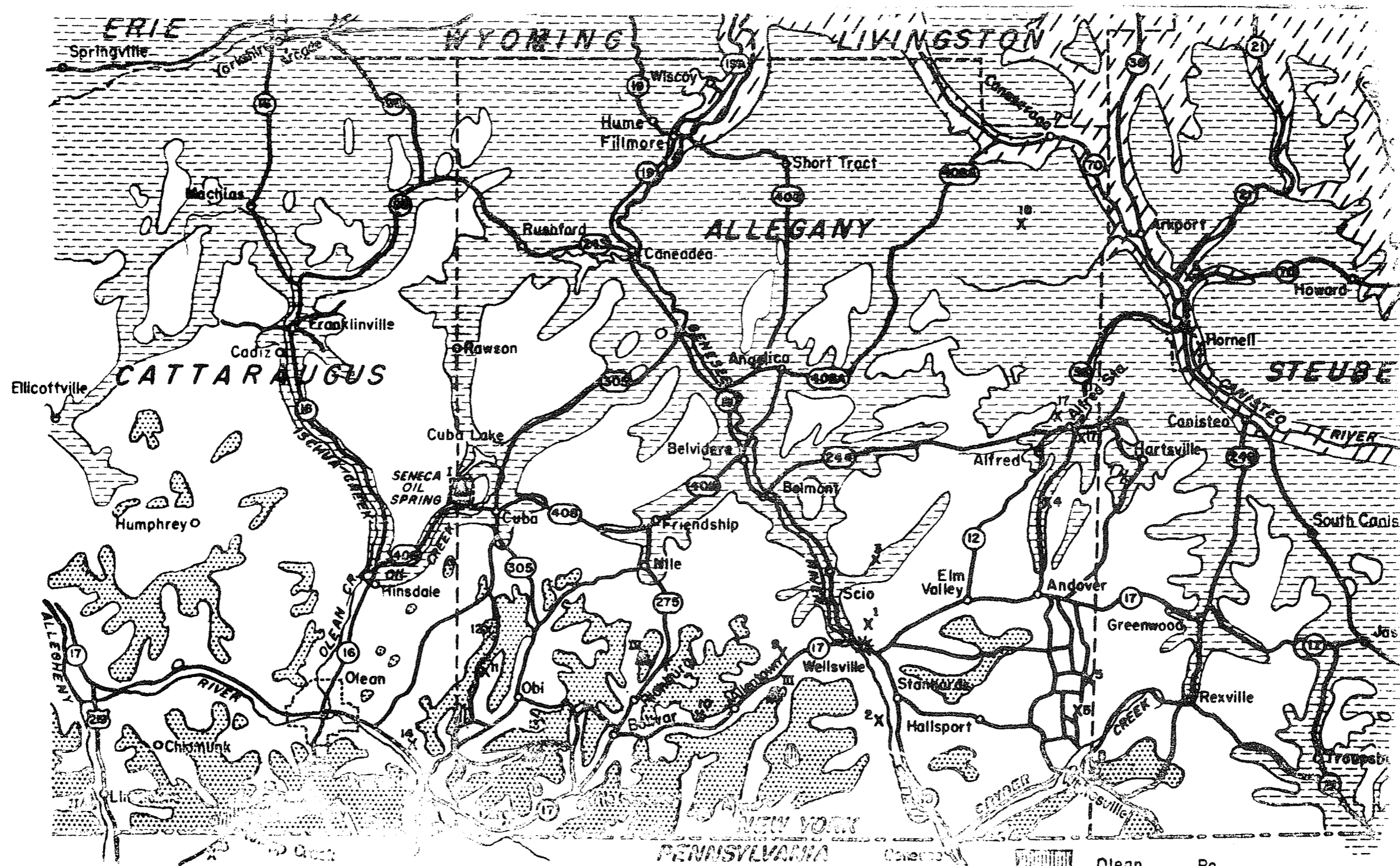

MAP 2
GEOLOGICAL MAP OF WELLSVILLE AREA
 0 5 10 15 20 MILES

X Station numbers of geological exposures
 ⚠ Places of historical oil and gas interest

	Olean	Po
	Conewango	Dco
	Chadokoin	Dcha
	Canadaway	Dca
	Chemung	Dchs

III - STRATIGRAPHY AND PALEONTOLOGY

by Lawrence V. Rickard, N. Y. S. Geological Survey

During the past 100 years the Upper Devonian rocks of New York State have received considerable attention from stratigraphers, paleontologists and petroleum geologists. Nevertheless a complete and satisfactory classification of these strata has not yet been obtained. Among the many different classifications proposed during the last 50 years the most recent include those by Cooper *et al* (1942), Woodruff (1942), Pepper and de Witt (1950, 1951, 1956), Sutton (1956) and Tesmer (1955). These classifications differ in the nomenclature applied to various units, e.g., names used for a rock unit, such as a formation or group, by some writers, are applied to time or time-rock units (ages, stages) by others. Complete agreement on the number and correlation of recognized rock units has also not yet been reached. Inasmuch as the Upper Devonian strata are still not thoroughly understood a more or less permanent classification satisfactory to a majority of workers probably will not be obtained for some time. For purposes of clarity, however, the strata encountered in the Wellsville region may be classified as indicated in the following description of rock units. (See also Table 2).

Since the youngest rocks described in the guidebook for the N. Y. S. G. A. meeting last year (1956) at Rochester were those found at the top of the Chemung group, it seems appropriate to continue this description of rock units in a similar fashion for the 1957 guidebook--thus completing the stratigraphic column of the Genesee River Valley, site of both meetings. Accordingly, several rock units encountered in the overlying Canadaway group which will not be seen during the meeting this year are included in the descriptions given below.

UPPER DEVONIAN

Chautauquan Series (Clarke and Schuchert, 1899)

CANADAWAY GROUP (Chadwick, 1933)

Includes beds between the base of the Dunkirk and the top of the Cuba. In this group the Caneadea, Rushford and Machias units contain the main oil producing horizons in New York State.

Dunkirk shale (Clarke, 1903)*

Overlying the Wiscoy shale at the top of the Chemung group in west-central New York is an interval of black or brownish-black shales to which the name Dunkirk is now restricted (Pepper and de Witt, 1951). Its relatively sharp lower boundary affords one of the most useful horizons in the Upper Devonian strata. The Dunkirk grades upward into the overlying South Wales shale and attains its maximum thickness in Erie County. It has been traced eastward to near Woodhull, Steuben County, where it is only a few inches thick. Fossils are not abundant in the Dunkirk shale, only carbonized plant stems and conodonts having been discovered in a few outcrops.

*Perrysburg "formation" (Pepper and de Witt, 1951)

In western New York all the recognized rock units present in the interval between the base of the Dunkirk shale and the base of the Laona sandstone have been considered members of one encompassing unit, the Perrysburg formation. Inasmuch as the Laona or its correlate has not been traced eastward into the Wellsville region the term Perrysburg cannot be rightfully applied to rocks of this interval in the latter area.

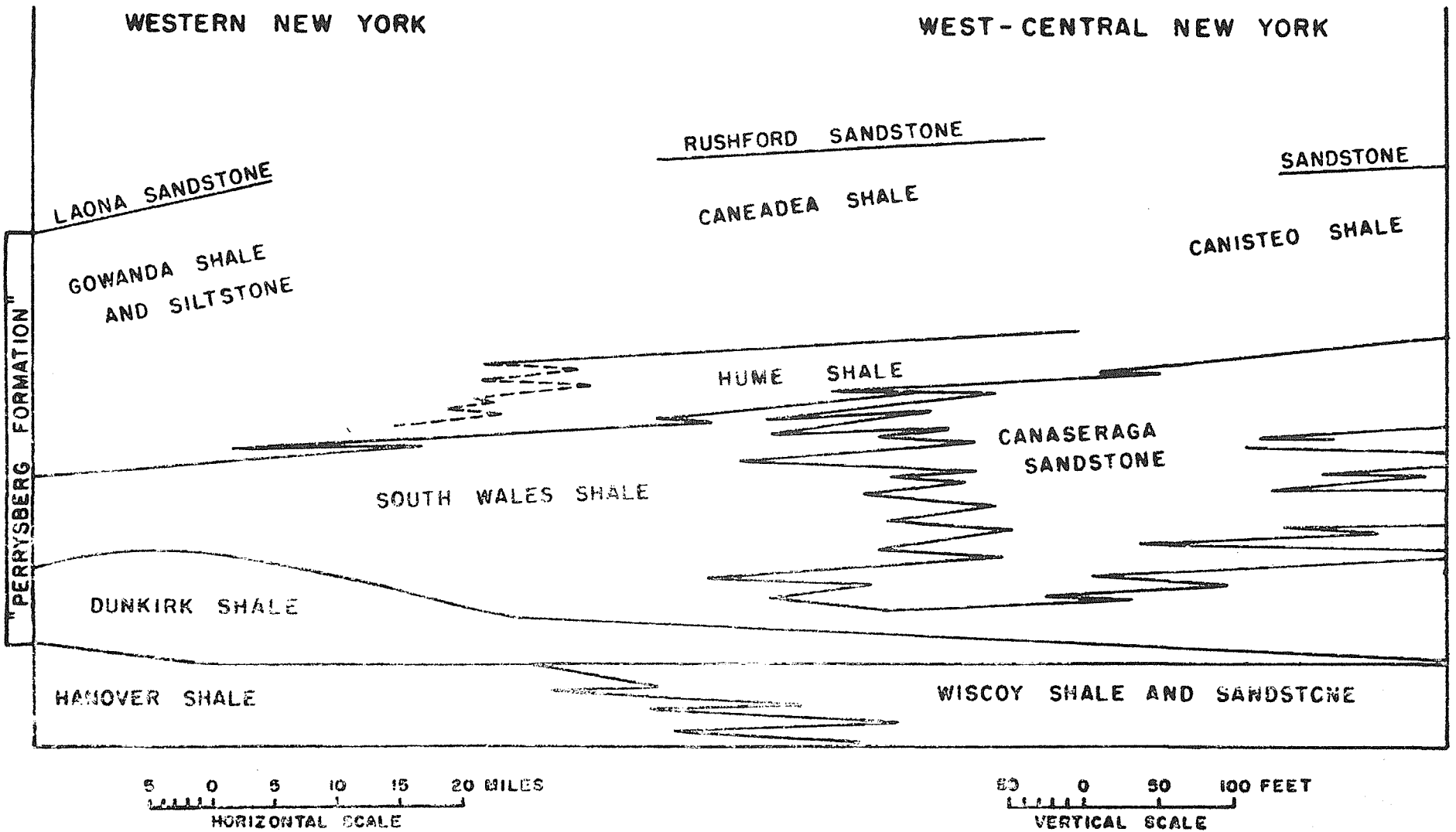

FIGURE 1
 UPPER CHEMUNG AND LOWER CANADAWAY STRATIGRAPHIC RELATIONSHIPS
 Modified from Popper and Gowen (1931)

Table 2 - General Stratigraphic Column of the Wellsville Area

*Those preceded by asterisk are the units seen on the trip (Skeleton section beneath Canadaway group)

Age		Rock Unit	Thickness (feet)		
Lower Pennsylvanian Pottsville Series		Sharon Shale *Olean conglomerate (Sta. 13 & 16) (Unconformity)	50-90		
Lower Mississippian Kinderhookian Series		Knapp "formation" (Unconformity)			
Upper Devonian	Chautauquan Series	Conewango Group	*Oswayo shale (Sta. 15) 150 ±		
			*Cattaraugus shale (Sta. 15) 375 ±		
			*Wolf Creek conglomerate (Sta. 11 & 12) 5 ±		
		Chadakoin Group	Germania "formation" (Sta. 5) 70 ±		
			Whitesville "formation" (Sta. 8) 300 ±		
			*Hinsdale sandstone (Sta. 2) 15 ±		
	Canadaway Group	*Wellsville "formation" (Sta. 1) 200 ±			
		*Cuba sandstone (Sta. 3) 40 ±			
		*"Machias" shale (Sta. 4) 400 ±			
		Rushford sandstone (Sta. 18) ?			
Senecan Series	Chemung, Naples & Genesee Groups	Caneadea shale 280 ±			
		Hume shale 0-35			
		(Canaseraga sandstone and South Wales shale (Sta. 6) 160-300			
		Dunkirk shale (Sta. 6) 20 ±			
		15 ±			
		Several units	Subsurface		
		Middle Devonian		Tully Hamilton	-1890
		Lower Devonian		Onondaga Oriskany	-2450 -2525
		Upper Silurian		Salina	
		Middle Silurian		Lockport Clinton	-3510 -3915
Lower Silurian		Medina	-3950		
Upper Ordovician		Queenston Oswego Pulaski	-402' -5050 -5190		
Middle Ordovician		Trenton ls.	-5930		
Lower Ordovician		Tribes Hill ls. dol.	-6780		
Upper Cambrian		Little Falls dol. Theresa Potsdam ss.	-7050 -7590 -8220		
Precambrian		granite, gneiss, etc.	0600		

South Wales shale (Pepper and de Witt, 1951)

For the gray silty shales and mudstones, 20 to 80 feet thick, overlying the Dunkirk, Pepper and de Witt have recently proposed the name South Wales. In and east of the Genesee River Valley this shale is largely replaced by the Canaseraga sandstone (See figure 1). Save for rare conodonts, no fauna has yet been discovered.

Canaseraga sandstone (Chadwick, 1923)

In and to the east of the Genesee River Valley, thin to massive siltstone beds appear in the interval occupied by the upper South Wales and lower Hume shales to the west. These siltstones are well developed near Canaseraga, Allegany County, from which their name is derived. They include a thin local sequence of fossiliferous shales and sandstones to which Luther (1902) applied the name Long Beards Riffs sandstone. Aside from the "Chemung brachiopods" which reportedly occur in the Long Beards Riffs sandstone, no fauna is yet known from the Canaseraga. Its thickness increases eastwardly from 160 to 300 feet. (Woodhull or Cameron?)

Hume shale (Pepper and de Witt, 1951)

Above the Canaseraga (or South Wales) a second dark gray or black shale interval, 0 to 35 feet thick, has been recognized for which the name Hume has been proposed. This shale has not been traced extensively because of a lack of exposures and does not appear to contain fossils, excepting conodonts.

Caneadea shale (Chadwick, 1933)

Pepper and de Witt (1951) restricted the name Caneadea to an estimated 280 feet of gray silty shales and gray siltstones found in the Genesee River Valley overlying the Hume and extending upward to the base of the Rushford sandstone. Complete exposures of this shale are unknown. A small brachiopod fauna has been discovered. It grades eastwardly into the Canisteo shale (Pepper and de Witt, 1951) which, although lithologically similar to the Caneadea, is not strictly coterminous with it.

Rushford sandstone (Luther, 1902)

The fossiliferous gray siltstones and interbedded gray shales of unknown thickness occupying the interval between the Caneadea below and Machias above are but poorly known. The boundaries, extent, fauna and correlation of this interval of sandstone known as the Rushford afford fertile grounds for future investigators.

Machias shale (Chadwick, 1923)

The Machias consists of fossiliferous gray shales and gray siltstones whose limits, both stratigraphic and geographic, remain as yet unknown. It lies between the Rushford and Cuba sandstones, is approximately 400 feet thick, and appears to be equivalent to the Northeast shale of western New York. This is the lowest unit that will be visited on the geological field trip and will be examined at Station #3.

Cuba sandstone (Clarke, 1902)

At Cuba, Allegany county, about 40 feet of gray siltstones and finetextured sandstones overlie the Machias shale. The geographic extensions and correlations of this sandstone have not yet been fully determined but it appears that the Cuba may furnish a useful stratigraphic marker similar to that afforded by the base of the Dunkirk shale. The Cuba is fossiliferous, containing the highest known occurrences of the brachiopod Tylothyris mesacostalis which is a common Canadaway fossil. Cooper (1942) classified the Cuba as the basal unit of the Conneaut group but the presence of T. mesacostalis has caused several writers (Woodruff, 1942; Tesmer, 1955) to suggest that it be transferred to the top of the underlying Canadaway. This stratigraphic unit can be examined at Station #3.

CHADAKOIN GROUP (Chadwick, 1923)

Includes beds between the base of the Wellsville and the top of the Germania. Approximately the same as Conneaut Group (Chadwick, 1934).

Wellsville "formation" (Woodruff, 1942)

The Wellsville, overlying the Cuba sandstone in the Wellsville region, is about 200 feet thick and is composed of thin sandstones or siltstones and interbedded shales. It is relatively fossiliferous, containing particularly brachiopods and pelecypods. Calcareous beds, abounding in fossils, appear at several horizons within the Wellsville. The type locality of the Wellsville will be visited. It is Station #1 on the geological map.

Hinsdale sandstone (Chadwick, 1933)

This sandstone, named from the village of Hinsdale, Cattaraugus County, is recognized with some difficulty in the Wellsville region. In the latter area it consists of about 15 feet of hard, fine-grained sandstone containing a few small quartz pebbles at irregular intervals. Brachiopods, sponges and sponge spicules have been recovered from the Hinsdale at a few outcrops. Its geographic and stratigraphic limits remain poorly defined. This stratigraphic unit will be examined at Station #2.

Whitesville "formation" (Woodruff, 1942)

Originally the lower 300 feet of the Chadakoin "formation" of Chadwick (1923), the Whitesville is composed of both fossiliferous marine beds and equivalent green cross-bedded sandstones of non-marine origin. Apparently the Whitesville was deposited near the shore line under oscillating marine and non-marine conditions. It forecasts the dominantly non-marine deposition of the overlying Germania. The type locality of the Whitesville is at Station #8 with probable exposures of Whitesville at Stations #9 and 10.

Germania "formation" (Woodruff, 1942)

Above the Whitesville approximately 70 feet of thin green sandstones interbedded with red shales immediately underlie the Wolf Creek conglomerate. The Germania represents a period of non-marine deposition and usually lacks fossils except for a rather abundant pelecypod fauna in thin conglomerate beds near its base. The Germania is found exposed on the hills between Andover and Whitesville, New York. (See Station #5 on the geological map).

CONEWANGO GROUP (Butts, 1908)

Embraces strata from the base of the Wolf Creek to the top of the Oswayo. Approximately the same as Venango Group (Carll, 1880).

Wolf Creek conglomerate (Prosser, 1892)

The Wolf Creek is one of the persistent flat pebble conglomerates of the Late Devonian in New York. In the Genesee Valley it overlies the non-marine Germania and underlies the predominately red Cattaraugus shales above. It is composed of quartz-pebble conglomerates and light-colored sandstones and siltstones whose average thickness is about 30 feet. Fossils are rare in the Wolf Creek conglomerate although pelecypods, cephalopods, crinoids, fish and plant remains have been found. The type locality is at Station #12. The Wolf Creek, at Station #11 in a more recent but now abandoned quarry will be visited.

CATTARAUGUS SHALE (Clarke, 1902)

The Cattaraugus consists of red and green shales interbedded with greenishgray sandstones, about 375 feet thick in the Genesee River Valley. Westward in the Salamanca and Olean quadrangles the Cattaraugus has been subdivided into three units which are, in ascending order: the Amity shale (Chadwick, 1925), Salamanca conglomerate (Carll, 1880) and Saegerstown shale (Chadwick, 1925). The Salamanca is also a flat-pebble conglomerate. The Cattaraugus shales of the Genesee Valley have not yielded marine fossils with the possible exception of a few pelecypods. This stratigraphic unit can be examined at Station #15.

Oswayo shale (Glenn, 1903)

Overlying the non-marine Cattaraugus shales on the tops of the highest hills in the Wellsville region and westward in New York a fossiliferous shale of marine origin is found. The age of this shale, known as the oswayo, is not yet satisfactorily determined. Some geologists place it in the Devonian whereas others have considered part or all of it to be of Early Mississippian age. Its characteristic guide fossil is the brachiopod Camarotoechia allegania, although fossils in the Oswayo are rare east of the Olean quadrangle. The Oswayo of the Wellsville region is about 150 feet thick and is disconformably overlain by the Olean conglomerate of Pennsylvanian age. This stratigraphic unit will be seen at Station #15.

LOWER MISSISSIPPIAN

Knapp "formation" (Glenn, 1903)

In the Salamanca quadrangle, west of the Wellsville region, a shale containing two thin conglomerates intervenes between the Oswayo and Olean and has been differentiated as the Knapp. Its age is as yet uncertain but most authors place it in the Lower Mississippian Kinderhookian Series. The Knapp is apparently cut out of the section to the east by the sub-Olean unconformity and does not extend into the Wellsville region. It has been suggested, however, that a part of the rocks classified as Oswayo found beneath the Olean at "Rock City" may represent the easternmost occurrence of the Knapp.

LOWER PENNSYLVANIAN

Olean conglomerate (Lesley, 1875) and Sharon shale (Rogers, 1858)

West of the Wellsville region, the Oswayo shale is unconformably overlain by 50 to 90 feet of massively bedded conglomerate containing rounded pebbles. This is the Olean conglomerate which outcrops at the famous "Rock City" southwest of Olean in Cattaraugus County. It caps the highest hills just north of the Pennsylvania-New York state line. It is overlain by a small remnant of the Sharon shale, the youngest Paleozoic rock encountered in New York State. The type locality of the Olean conglomerate (Station #16) will be visited. The Olean is the highest unit which will be seen on this trip.

by Lawrence V. Rickard, N.Y.S. Geological Survey

The Devonian system is well developed in New York and Pennsylvania where 20,000 to 15,000 feet of strata, largely shales and sandstones of Middle and Late Devonian age, are found along the axis of the Allegheny synclinorium. These clastic rocks were derived from sediments carried westward and northwestward from mountains along the eastern coast of North America produced by the Acadian disturbance. The entire Middle and Upper Devonian sequence is usually interpreted to be a large delta or, more probably, a series of coalescing deltas forming a vast compound delta. It is widely known as the Catskill delta, named from exposures in the Catskill Mountains of eastern New York

Both marine and non-marine depositional environments are well represented. Fine-grained sediments accumulated in the marine waters of the inland seas; coarser deposits formed on the alluvial plains near the shore lines to the east. As the Acadian disturbance in the east and subsidence of the western basin continued the delta grew larger its shore line migrating westwardly and northwestwardly. The non-marine deposits of the Late Devonian extend further west than those of the Middle Devonian and overlie earlier marine beds. Thus a complete series of depositional environments is encountered in vertical sequence as well as laterally across the state. (See Figure 2). The non-marine conglomerates, red sandstones and shales grade westwardly into gray sandstones and shales bearing marine fossils which, further west, give way to interbedded siltstones and shales and finally soft calcareous shales, abundantly fossiliferous. Still further west these beds are replaced by black shales bearing meager faunas, largely of pelagic origin. These different phases were originally interpreted as successive formations, each younger than the more seaward deposits beneath it. It is only recently that their lateral gradation into each other and equivalency in age has been recognized.

Within the Wellsville region nearly all of these depositional environments can be recognized. The Dunkirk, South Wales and Hume shales represent the black or dark gray shale phase. More landward fossiliferous marine phases are contained within the overlying rock units of the Canadaway and lower Chadakoin groups. Near the shore line and upon the subaerial surface of the delta other phases were formed, represented by the Wolf Creek conglomerate and the non-marine red beds of the Germania and Cattaraugus.

The westward migration of the shore line was not uniform; periods of transgression by the seas upon the subaerial surface of the delta alternated with intervals during which the shore line advanced seaward. These alternations were caused largely by changes in the balance between the rate of sedimentation and rate of subsidence. This produced variations in the type of sediments being deposited at a given locality, variations which are now reflected in the differing rock types encountered in vertical sequence of that place. If subsidence exceeded sedimentation, the seas advanced over the delta and fine-grained sediments came to lie upon older, coarser deposits. As the rate of subsidence decreased and sedimentation continued, the grain size of the deposits at that place increased. A renewed period of subsidence in excess of sedimentation would cause fine-grained sediments to be re-introduced in that locality

On this manner the variations in rock type seen in vertical sequence in one section and the lateral gradation of differing rock types into each other were produced. Recent workers in Upper Devonian stratigraphy have recognized these variations and have interpreted them as evidence of cyclic deposition. The application of this interpretation is controversial.

TYPICAL UPPER DEVONIAN FOSSILS

FROM

ALLEGANY AND CATTARAUGUS COUNTIES, NEW YORK

S P O N G E

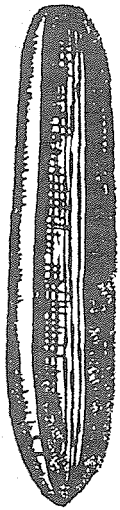

Prismo dictya
(x1)



Spicules
(magnified)

C O N O D O N T S

(x20)



Polygnathus

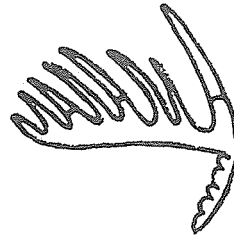

Ligonodina

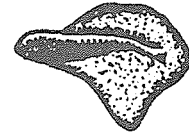

Palmatolepis

P E L E C Y P O D S

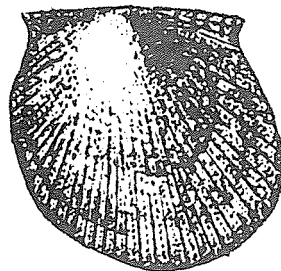

Pterinopecten suborbicularis
(x1)

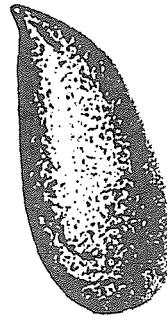

Mytilarca chemungensis
(x1)

C E P H A L O P O D



Orthoconic nautiloid (x1)

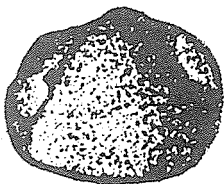

Schizodus oblatius (x1)

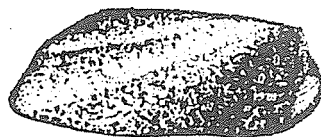

Sphenotus contractus (x1)

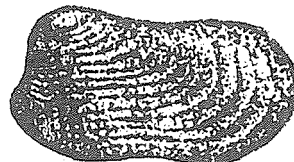

Grammysia communis (x1)



Ptychopteria saoi (x1)

B R A C H I O P O D S

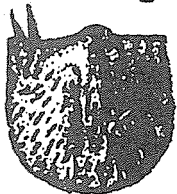

Productella lachrymosa (x1)



Athyris angelica (x1)



Tylothyris mesacostalis (x1)



Camarotoechia contracta (x1)

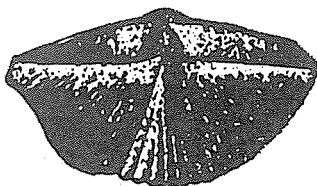

Cyrtospirifer disjunctus (x1)

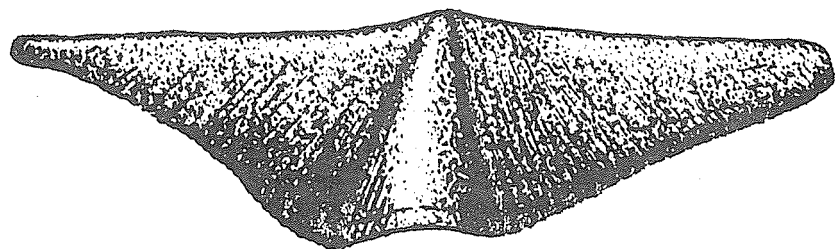

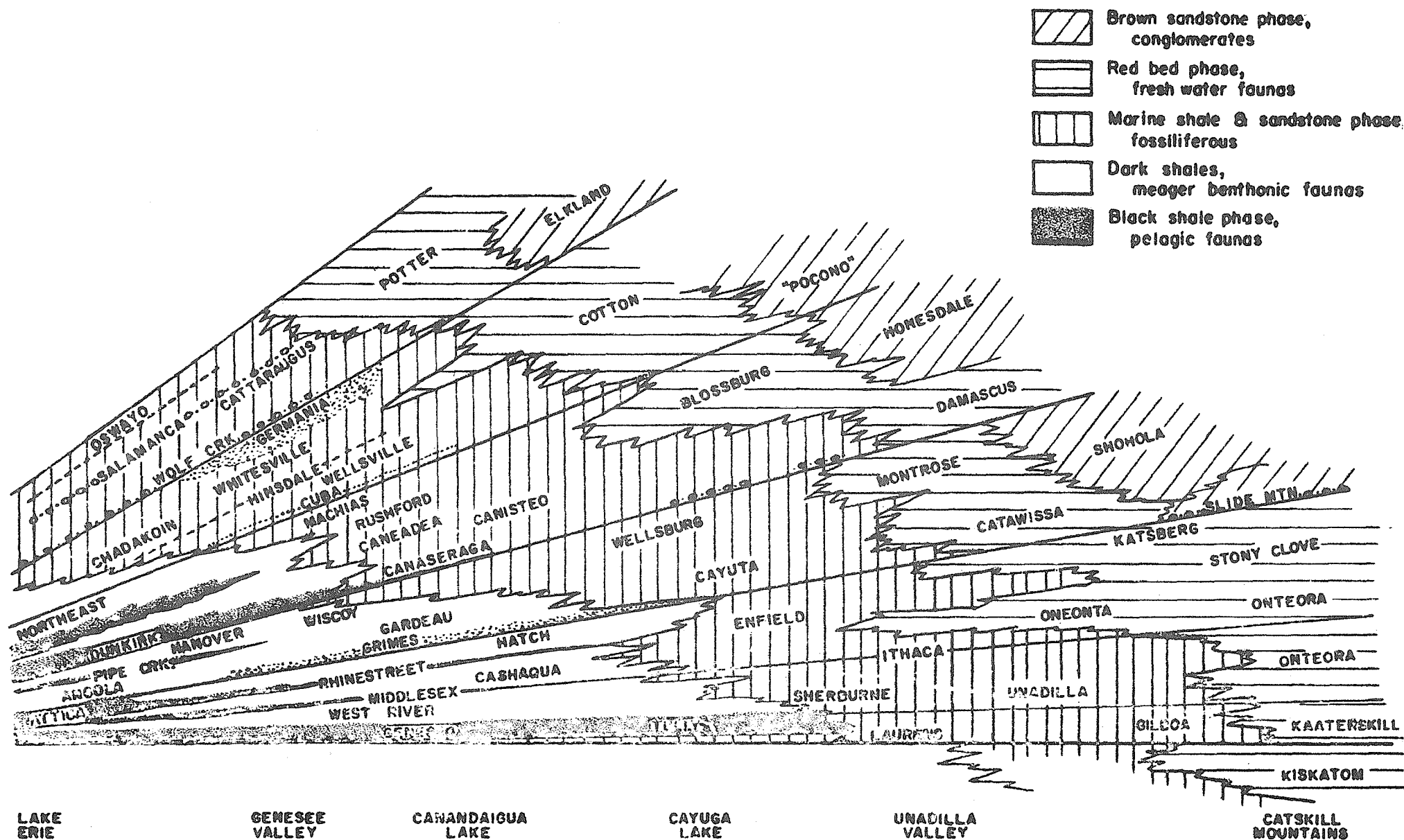
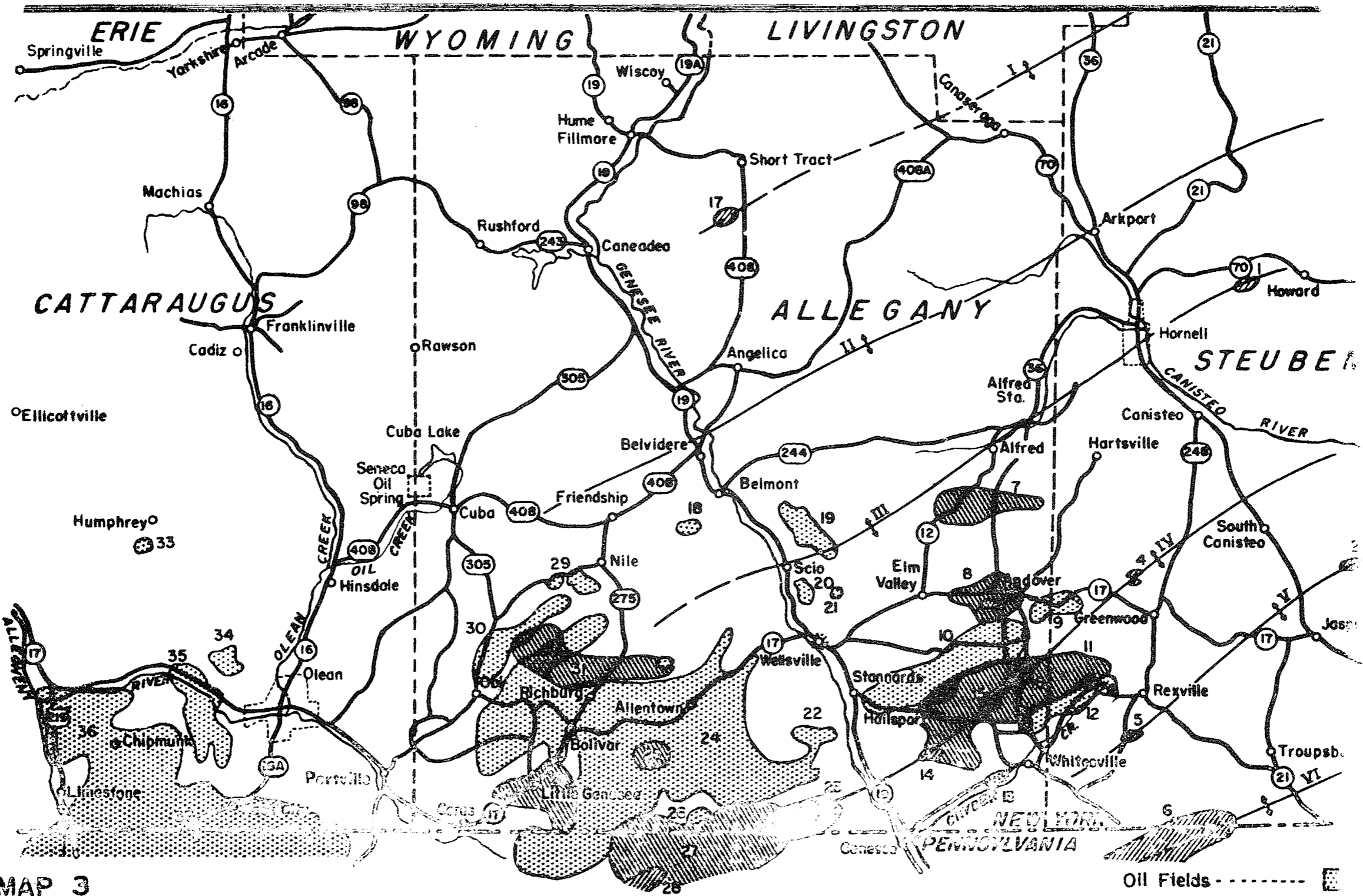

FIGURE 2
 UPPER DEVONIAN DEPOSITIONAL PHASES
 SOUTHERN NEW YORK

TABLE 3 - KEY TO OIL AND GAS FIELDS AND ANTICLINES OF MAP 3

<u>Oriskany</u>	<u>Shallow Gas</u>	<u>Shallow Oil</u>
	OIL AND GAS FIELDS	
1. Howard		
2. Jasper		
3. Woodhull		
4. Greenwood		
5. Gilbert Hill		
6. Harrison		
	7. Alfred	
	8. Andover	8. Andover
		9. Greenwood
		10. Fulmer Valley
	11. Willing-Independence	12. Potter-Marsh
		13. Cryder
14. Beech Hill		
15. Independence W.		
16. Independence N.		
17. Allen		
		18. Corbin Hill
		19. Scio (Main)
		20. Scio (shallow)
		21. Madison Hill
		22. Fords Brook
23. State Line (north & south)		24. Allegany (main)
	25. Gas cap	26. Alma
	27. Alma	
28. Sharon		29. Nile
		30. Clarksville
	31. Bolivar	
	32. Little Genesee	
		33. Humphrey
		34. Five Mile
		35. Bradford Sand
		36. Chipmunk
		37. Bradford (main)
38. Allegany St. Park		
	ANTICLINAL AXIAL TRENDS	
	I - Lodi	
	II - Severne Point	
	III - Firtree	
	IV - Watkins - Sharon	
	V - Alpine	
	VI - Van Etten - Harrison	



MAP 3
STRUCTURE MAP OF WELLSVILLE AREA
WITH OIL AND GAS FIELDS

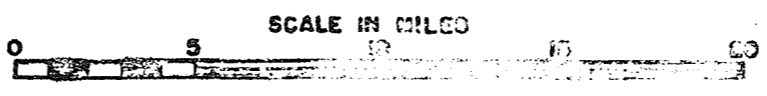

Oil Fields -
 Shallow Gas Fields -
 Deep Gas Fields -

V - RELATION OF OIL AND GAS PRODUCTION TO STRUCTURE
IN THE DEVONIAN OF SOUTHWESTERN NEW YORK

27

by C. D. Whorton, Wellsville, N. Y.

The horizons which have produced the greater part of the oil and gas in southwestern New York in their descending order are as follows:

Chipmunk
Scio
Bradford Second
Penny
Richburg
Bradford Third
Clarksville
Waugh and Porter
Oriskany

The position of the shallow sands and their relation to each other are shown in chart 1. The Bradford second sand of the Bradford, Pennsylvania and Limestone, New York area is probably very near the time equivalent of the Scio sand of Allegany County, New York. The Bradford third sand is also considered by many to be approximately the same time equivalent as the Richburg sand of Allegany County, New York.

The relation of oil and gas production in all the commonly called shallow sands to structure can be discussed together as they have generally the same characteristics.

The traps in which production (both oil and gas) is found are in the main stratigraphic traps. These are in many cases sand lenses in which the accumulations are controlled either by the permeability and porosity of the sand or changes in the deposition. Some of these areas are large in extent as the case of the Bradford field (Bradford third sand) and the Allegany field (Richburg sand). Both of these fields have areas within the limits of the oil production which produce gas only. In general this gas production occupies the highest structural part of the sand lense.

The northern part of the Appalachian Synclinorium is made up of a series of rather prominent anticlinal and synclinal folds with their axes trending approximately parallel to the long axis of the Synclinorium. These folds die out gradually northwestward. The oil pools of this area are located along the northwestern margin of this belt where the folds have become broad and gentle. The structure of both the Bradford field and the Allegany field is partially anticlinal. The regional dip of the surface beds is slightly west of south at the rate of about forty feet per mile. In the Allegany field the main pool lies on the top and south flank of the northeast-southwest trending Fir Tree anticline and extends across the syncline into considerable reversal of dip at the southern edge of the pool. In the Bradford field there is some down dip water, however, the oil-water contact does not maintain a structural level, as this contact rises structurally up regional dip. In the Allegany field there is less evidence of any distinct relationship between structure and oil-water contact.

The smaller pools in the Allegany area occupy many different relationships with regard to the folds mentioned above. The Fulmer Valley and Greenwood pools are lenses on the north flank of the Sharon-Watkins anticline, southeast of the main Allegany pool, while the Marsh pool lies over the crest on the southeast limb of this fold. The Cryder Creek pool, a small sand lens, is farther down the flank near the axis of the Oswayo Syncline. The main Scio pool lies across the top of the Fir Tree anticline, the same anticline which runs through the main pool of the Allegany field, but the long axis of the sand lens forming this pool is at right angles to the anticlinal axis. This, however, is the exception rather than the rule as the axes of these small pool sand lenses are usually parallel with the regional folds. Generally as producing sand lenses

CHART NO. 1 SAMPLE CORRELATION SHOWING APPROXIMATE POSITIONS OF OIL HORIZONS

Compiled from Bradford Hill 220
 24000' for Bradford thickness
 which was taken from C. D. Jones
 Perryburg from USGS on Chart 98

AGE	SERIES	STAGE	GROUP	FORMATION	LITHIC	UNITS
UPPER DEVONIAN	CHAUTAUKUAN	CASSADAGA	CHADAKOIN	GERMANIA		
				WHITESVILLE		
				WELLSVILLE		
				CUBA		
				MACHIAS		
				BRADFORD		
				CANADAWAY		
				PERRYBURG		
				HUME		
				SOUTH WALES		
LOWER DEVONIAN	CANASERAGA	DUNKIRK				

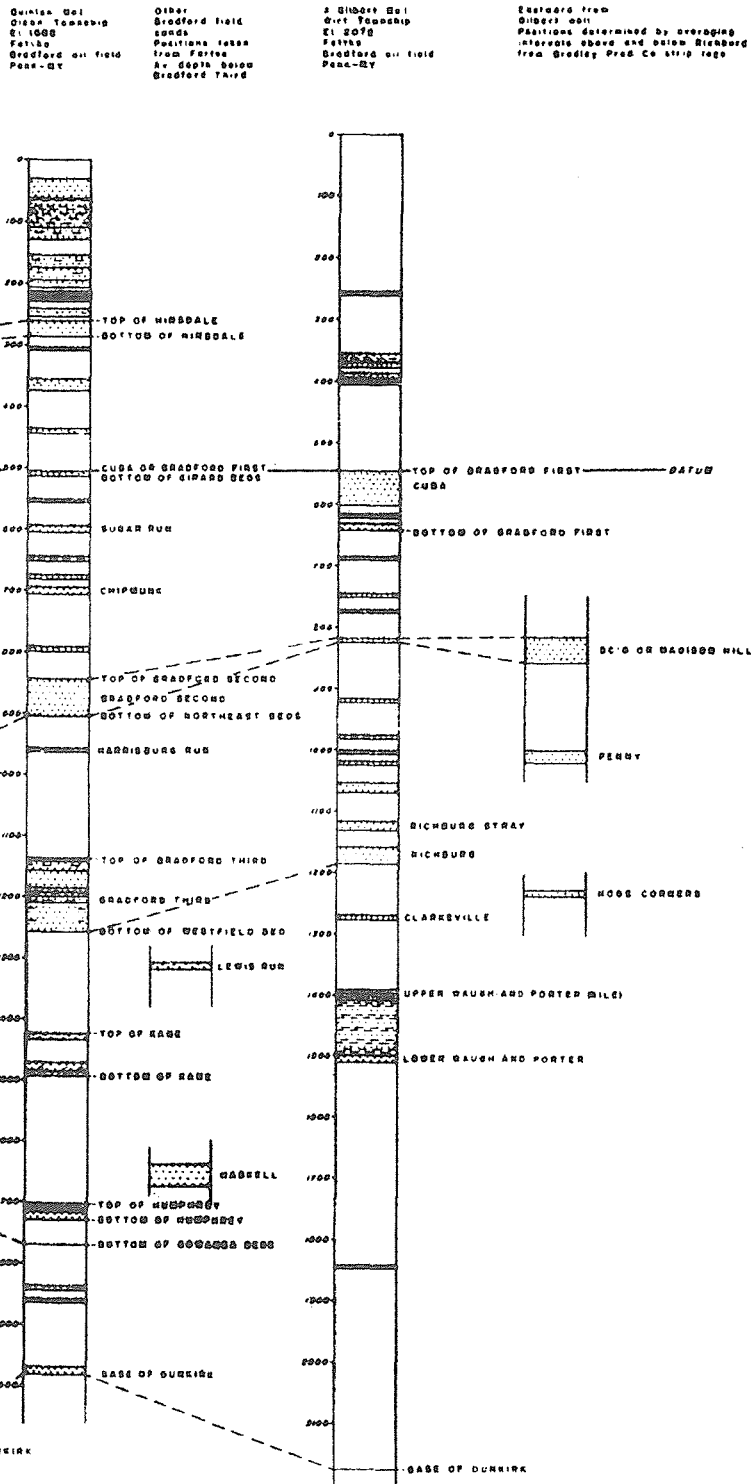

Quinta Hill
 Dixon Township
 El 1850
 Feltus
 Bradford oil field
 Page-GV

Other
 Bradford field
 wells
 Positions taken
 from Feltus
 by Edith Deane
 Bradford Third

2 Gilbert Hill
 Dix Township
 El 2070
 Feltus
 Bradford oil field
 Page-GV

Eastward from
 Gilbert Hill
 Positions determined by averaging
 intervals above and below Richford
 from Bradley Prod Co strip logs

occur succeedingly higher on the flanks of the folds they produce gas instead of oil. As stated above, even though production in the sand lenses is affected by the regional structure, the controlling factor of both shallow oil and gas traps is lenticularity and physical variations of the sands.

The occurrence of gas in the Oriskany sandstone of lower Devonian age in southern New York and Pennsylvania is due to accumulation in structural traps. The gas pools mainly occupy elongated domes along the prominent anticlines running through this area. As mentioned earlier the axes of these folds approximately parallel the axis of the Appalachian Synclinorium and run in general northeast and southwest. These folds have their steepest limb on the southeast flank. They diminish in intensity progressively toward the northwest or in the direction away from the Allegheny Front. The last fold easily recognized from surface dips is known as the Sharon-Watkins anticline (see map 3).

The location of the pools along these folds is controlled by saddles along the axis, faults, porosity and permeability of the sand and by the sand pinching out up dip. The most common type of traps are elongated domes which are almost always accompanied by faulting on the southeast or steep limb side. Faulting may occur in almost any place on these structures in the areas of greater intensity. These faults, however, usually parallel the long axis of the major folds. They are usually underthrusts or upthrusts. Faulting has in many cases divided the main domes into two or more separate accumulation areas. Lack of porosity and permeability in the sand and in up dip direction or a pinchout of the sand will give the same effect as saddling or cross faulting. In some cases it has been noted that saddling along a fold is often accompanied by the sand having less porosity and permeability. The pools are always surrounded by salt water except where production is cut off by a fault, pinchout, or an area of no porosity at a point higher on the structure than the water-gas contact. The water-gas contact is structurally constant around a given pool.

In a few instances pools have been found in which the trap is a pinchout of the sand up dip across a structural nosing. The Allegheny State Park pool, which was discovered late in 1955, is the best example of this type of structure. This pool also has salt water on the down dip side. To date very few pinchout pools have been found in New York and Pennsylvania. It must be pointed out, however, that neither surface structure nor any of the known geophysical methods can be used effectively in searching for this type of trap. The geologist can only be guided by the general knowledge of the line of pinchout, which is often very erratic, plus any nosing which can be found across the pinchout. It can readily be seen that the odds against locating this type of pool are great. It is very possible that further search will result in the discovery of more of this type of pool, particularly along the main Oriskany sand pinchout in New York State.

All of the surface structures of any appreciable size in southwestern New York State have had at least one Oriskany sand test. It is not intended to suggest that other small structures will not be found that may produce Oriskany gas but there are certainly none left untested which could develop into major pools. It is the writer's opinion that any large future gas production in southwestern New York State must either come from the Oriskany sand pinchout type of structure or from deeper horizons. It is very unlikely that new oil production of any size will be found above the Oriskany horizon.

VI - SUB-ORISKANY OIL AND GAS POSSIBILITIES

A. GEOLOGY OF NORTHEASTERN APPALACHIAN BASIN

By C. D. Whorton, Wellsville, N. Y.

Many geologists do not believe that the Appalachian Basin has been adequately prospected, in the light of modern methods and revised geologic thinking, in so far as the possibilities of production of oil and gas from horizons below the Oriskany are concerned. This discussion will only cover the northeastern portion of the Basin as this is the area with which most New York State geologists are familiar and in which they are most interested.

In descending order below the Devonian Oriskany Sandstone, the following portions of the generalized section offer the most interesting speculative possibilities:

Devonian	Helderberg Limestone
Devonian-Silurian Contact	
Silurian	Lockport (Niagara) Limestone Clinton-Medina Sands
Ordovician	Queenston Sandy Facies and Oswego Sands Trenton and Black River Limestones
Ordovician-Cambrian Contact	
Cambrian	Theresa Dolomite Potsdam Sands

The general characteristics of these horizons are fairly well known from work that has been done on their outcrops which, for the most part, can be found along the rim of the basin. Far less is known about their characteristics in the places in which we are most interested, namely toward the center of the Basin where they are covered by thousands of feet of sediments. It seems reasonable to suppose that where the requisite porosity-permeability characteristics are combined with suitable structural and stratigraphic closure some of the above formations should yield commercial production.

In recent years the presence of a buried ridge known as the Adirondack Axis (Kay, 1942), running from the Adirondack Mountains toward the northeastern corner of Pennsylvania and thence in the direction of Harrisburg, has been postulated by several well known geologists. This axis if present would cross the northeastern end of the Appalachian Basin and would afford possibilities of pinchout sedimentation traps on both sides with large drainage areas in both directions. As mentioned above, very little is known of the section in question as to whether there would be adequate source beds and reservoir rocks with porosity and permeability. Down the flanks of this axis and toward the center of the basin it seems reasonable to suppose from the information we do have that favorable conditions could exist.

The few wells in New York State and north and eastern Pennsylvania which have tested the above horizons have been disappointing. It must be pointed out that the most favorable areas from a sectional standpoint have not been tested, probably due to the great depths at which the prospective horizons would be encountered.

by W. J. Yahn, DYM Corp.; Olean, N. Y.

Based upon the shallower production of the area and general geologic principles, we may expect primary and fracture porosity in the clastic rocks and primary, fracture, and secondary porosity in the carbonate rocks.

The best textural development of the sands will occur along the old shore lines which can only be determined by an intense study of the transgressive-regressive relationships and their association to earth movements and older geologic structures.

The carbonate rocks, on the other hand, depend very largely upon the development of the secondary solution properties associated with unconformity surfaces or hiatuses in the depositional process caused by relative uplift of an area. The recognition of such features from well samples requires exceptionally detailed work and a vast working knowledge of carbonate deposition and alteration.

The principal problem, then, is to ascertain the structural framework of the area, in terms of the buried Pre-Cambrian structural features, to determine the direction of the applications of force to this framework, and to establish the periods during which these forces were applied.

The overall picture is greatly complicated by the fact that the structural features below the Silurian salt beds may be independent of the Devonian and later structural movements.

The solution to these problems is not impossible. The best approach is from the regional study to the local and back to the regional. For further information reference should be made to Fettke (1948), Kreidler (1953), Swartz (1948) and other papers by the same authors and other students of the Appalachian area.

The only requisites for ultimate success are patience, diligence and adequate information.

by G. C. Borland - N. Y. State Nat. Gas Corp.

New York State Natural Gas Corporation is a wholesale gas supplier to 21 major gas distributing companies in Pennsylvania, Ohio and New York. With the exception of the New York City district its market area includes virtually all of the state of New York.

During the last 15 years underground storage of gas in previously depleted gas field sands has become an important phase of gas company operations. The Harrison Field is one of the storage fields operated by New York State Natural.

State regulations limit the number of a utility's domestic gas consumers to the number that the utility can supply with an adequate, uninterrupted supply of gas. This in effect means that the number of domestic consumers is limited to the number the utility can supply on an extremely cold day. Industrial customers of a utility obtain lower gas rates but their supply is interruptible.

Therefore a utility can expand the number of its domestic gas consumers only if it does one of two things: (1) Cuts off or reduces the gas to its industrial customers during very cold weather and diverts that gas to its domestic consumers; (2) Increases the flow of gas to its domestic consumers during very cold days (called peak days in the gas business) by obtaining more gas from the wholesale gas supplier.

Since the first alternate usually results in a financial loss to the industrial customer the expanding utility increases the amount of its gas supply on peak days.

Quite a few of the utilities which New York State Natural supplies with gas have a contract which states that N.Y.S.N. will supply them with all the natural gas they require at any time they require it. This puts a tremendous strain on the N.Y.S.N. gas supply during cold weather, since its supply does not fluctuate very much. To meet this winter demand the company has developed 6 storage fields. Some are jointly financed. One of these is the largest storage field in the world in terms of amount of gas stored and horsepower used in storage operations. The Harrison field is financed jointly with Tennessee Gas Transmission Co.

Gas requirements of the domestic gas consumer fall into two types:

1. Fixed load. This consists of the gas used to run cooking stoves, gas refrigerators, water heaters, gas clothes dryers, etc. This load does not fluctuate much from summer to winter.
2. Space heating. Gas used in heating stoves, furnaces, etc. This load fluctuates tremendously and is the direct cause of having to use underground gas storage.

Since underground storage requirements are directly related to space heating load it follows that the underground storage requirements are also directly related to the temperature of the market area.

Studies of gas consumption in relation to U. S. Weather Bureau reports of the market area show that the average domestic gas consumer starts to use gas for space heating any time the average daily temperature drops below 65°. He uses 30 cubic feet of gas per day for every degree below 65°. If the daily temperature is 64° he will use 30 cubic feet. A one degree deficiency (below 65°) in the average daily temperature is called a degree day deficiency. In other words, if the average daily temperature for one day is 64° you have a 1 degree day deficiency. If the average tem-

perature for a day is 35° you have 30 degree day deficiencies.

33

It is thus possible by calculating the number of degree day deficiencies during an average winter to anticipate what the demands for space heating gas will be. This is done simply by multiplying the number of degree day deficiencies per winter by 30 cubic feet by number of customers using space heating.

Records for the Pittsburgh, Pennsylvania area show that there are 5614 degree day deficiencies in the average winter. So the average space heating requirement per customer for an average winter's heat in that area is 5614 times 30 cubic feet or 168,420 cubic feet.

Utilities usually also calculate a requirement based on the coldest and warmest winter in their market area. There is a variation of about 20% from the average figure for gas requirements during the coldest or warmest winter. In that way the utility can figure what its average, maximum and minimum requirements for the winter may be. These estimates of requirements are usually furnished to the wholesale gas supplier several years in advance so he can adjust his amount of gas in storage accordingly.

Amount of gas actually in storage usually represents a smaller figure than the largest amount of gas possibly required to meet all the demands (domestic and industrial) of all the utilities for the coldest winter likely to occur.

Desirable characteristics of a storage field include: large open flow wells (so gas can be injected and withdrawn from the sand quickly); location close to market area (so gas can be delivered quickly); high total gas capacity; and well defined limits (so that no gas migration is likely to occur).

The Oriskany sand gas pools of this region provide ideal storage areas. They are all former gas pools from which the original gas was withdrawn in the 1930-1950 period.

DESCRIPTION OF ORISKANY SANDSTONE

The Oriskany sandstone is generally a medium grained, dark to light gray quartzitic sandstone. Porosity is relatively low, averaging only 9 per cent. Productivity of the sand, however, is greatly increased because of fracturing, which is in part associated with the faulting present in each productive area. An additional factor of productivity seems to be the increased permeability associated with structural highs. It is probable that slight folding took place during deposition, causing the reworking of the sand deposits along the present structural highs and thereby causing increased porosity and permeability. (1)

The Oriskany pools of northern Pennsylvania and southern New York are large capacity and high productivity pools with well defined limits. These factors are the essential characteristics of ideal storage pools and are indicative of the utility of the Harrison field as an underground storage pool.

HARRISON FIELD

NATURAL CONDITIONS

The Harrison field is located in Bingham and Harrison Townships, Potter County, Pennsylvania and the Towns of West Union and Troupsburg, Steuben County, New York. The field is made up of three separate productive areas, the Harrison East End, Harrison West End, and the Brookfield pools. The latter is separated by a fault from the main producing area and has produced only a negligible amount of gas; it is not under con-

(1) F. H. Fim, "Geology and Occurrence of Natural Gas in Oriskany Sandstone in Pennsylvania and New York" Bulletin of the American Association of Petroleum Geologists, Vol. 33, No. 3 March 1949, p 314.

sideration for underground storage at this time. (2)

The Harrison East End Pool was discovered on June 10, 1934 with the completion by New York State Natural, of Well N-24 which had an open flow of 18 million cubic feet of gas and an original rock pressure of 2140 pounds. The Harrison West End Pool was not discovered until September 25, 1935, and it is estimated that the original pressure equalled the discovery pressure found in the East End Harrison area.

During active development, New York State Natural drilled eight productive wells in the East End Area and one well in the West End Pool. Outside operators were also active, drilling fourteen productive wells in the East End and five wells in the West End Pool. The original open flows encountered were somewhat lighter than those typical of Oriskany pools. They ranged from 505,000 cubic feet to 22.5 million cubic feet of gas per day in the East End Pool and 7.6 million to 20 million in the West End pool with the exception of one well in the East End Pool completed in 1943 with an open flow of 128,000 cubic feet, and a rock pressure of only 187 psig. It should be noted that several of the lighter open flow wells were drilled late in the productive period at a time when pressures were relatively low. Such wells would naturally have had a higher open flow at original reservoir pressures.

The Harrison field is located at the junction of the Harrison and Hebron Anticlines and covers an approximate area of 10,800 acres. The merging of the anticlines has caused the structural aspects of this pool to differ somewhat from a typical Oriskany pool found in this region. Faulting has caused the pool to be separated into two production areas; each of which has a vertical closure of approximately 125 feet. The faulting undoubtedly took place in early Devonian time, a fact made evident by the relatively minor evidence of faulting apparent in the shallower Dunkirk Sandstone, found near the surface. (3) See map no. 4 for subsurface structure.

The Oriskany Sand is found at a depth of about 5,000 feet. The thickness averages approximately 32 feet, with the pay zone varying from one to nineteen feet, and with an average pay of six feet for the entire pool. The sand is medium grained and light gray with an average porosity of 9 percent. These characteristics indicate that the productive horizon is harder and somewhat less porous than that typical of gas pools in the immediate area. The more prolific wells are found higher on the structure indicating a direct relationship between structure and porosity. The probable reason for this is that folding took place during deposition, causing greater reworking of the sand at the top of the structure. The relatively tight sand and lesser pay thickness in this pool is the reason for its smaller reserve per acre (about $3\frac{1}{2}$ million cubic feet) in comparison with other fields of the region which vary between $4\frac{1}{2}$ and 10 million cubic feet per acre.

The Harrison pool has all the required characteristics of an ideal storage pool in that it has a high deliverability, is definitely limited by nonproductive wells and has a large capacity. The East End Pool, because of its larger capacity, may be used on a steady load basis, while the West End Pool, with its smaller capacity, may be held at high pressures, thus furnishing high deliverability for periods of short peak requirements. This condition of operation affords a flexibility which is found in very few storage pools of the Appalachian Area.

USE AS STORAGE POOL

After the decision has been made to use a pool for storage it is necessary to obtain storage rights from the lease owners or land owners. Some wells still have production "strings" of casing in them. These wells usually don't cost too much to recondition, since about all that is necessary is to put on fittings at the top of the well

- (2) From Federal Power Commission report written by R. J. Murdy, Chief Geologist, New York State Natural Gas Corporation, and T. A. Kuhn.
- (3) See footnote (1). P330.

which will be safe for the pressure used to inject gas into the well. There have been 11 wells reconditioned in the Harrison field at an average cost of about \$10,000 apiece.

Most of the wells have had the production string of casing ripped, and the casing pulled out of the hole. In redrilling operations attempts are made to clean out the well to bottom and run smaller casing inside the short length of casing at the bottom of the well. There have been 17 wells in the Harrison field redrilled at an average cost of \$24,000 apiece.

To completely fill the storage pool in the summer time and get the gas out quickly in the winter time it is usually necessary to drill additional wells. There were originally 28 wells in the Harrison field. To obtain the delivery of gas which we required we drilled 31 additional wells. These have cost an average of about \$50,000 apiece.

Maximum pressure in the Harrison field is expected to reach 2000#. At that pressure, the pool is expected to hold $33\frac{1}{2}$ billion cubic feet of gas (roughly 23 million dollars worth at 70 cents per thousand - approximate local retail price). Maximum storage pressure will be about 140 pounds less than the original rock pressure of the field. At peak capacity the pool has a theoretical deliverability of about 300 million cubic feet of gas per day.

It has cost approximately 8 million dollars to fix up this field for storage. This includes cost of drilling and reconditioning wells, constructing compressor station, laying pipelines etc.

The productive portion of the field is about 6 miles long by 3 miles wide.

The pool is designed to:

1. Turn over 60% of its maximum capacity every year (i.e., about 20 billion cubic feet).
2. Have an average withdrawal rate of 133 million cubic feet per day.
3. Have a potential deliverability of 153 million cubic feet of gas per day at the end of the gas withdrawal period when the average pool pressure is 800#.

Topographic elevations in the field range from 1800 to 2223 above sea level. Within the field is a watershed divide between the Great Lakes - St. Lawrence River waters and the Susquehanna River drainage. A few miles to the west there is a three way continental divide between the Great Lakes - St. Lawrence River, Atlantic Ocean, and Gulf of Mexico drainage.

HARRISON VALLEY STATION

Compressors used consist of 5 large engines of 2000 horsepower each. Each of these weighs 93 tons and costs \$186,000 apiece. One smaller engine is used which develops 1100 horsepower. It weighs 75 tons and costs \$100,000.

It took about 5 months to build the station. It was completed in January of 1956.

Total cost of entire plant and equipment was about 4 million dollars.

The station operates 24 hours per day. Three men are on duty at all times.

The piping set-up at the station is actually more flexible in operation than the simplified diagram indicates (See Fig 5 with road log for trips B1-B2). In practice

gas can be taken from or discharged into either or both of the New York State Natural and Tennessee Gas Transmission Company lines.

The sketch below shows the relation of the Harrison Valley gas field and station to the area and may be of assistance to those departing for home from trip B2.

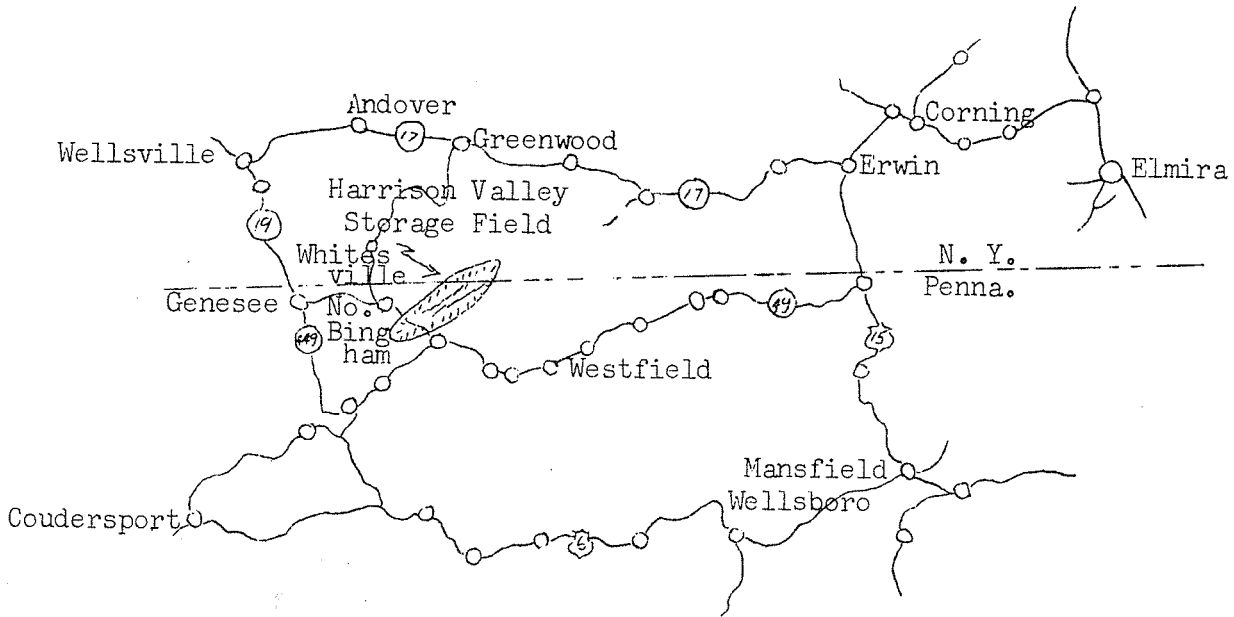

by K. R. Cochran, M.M.Lineman, W.H.Young, Jr. - Bradley Producing Corporation
J. C. Waterman - Thornton Co.

PRIMARY RECOVERY

The Allegheny Oil Field in New York is typical of fields whose primary recovery is produced by dissipation of the energy supplied by gas in solution in the oil. Secondary recovery must be obtained by restoring energy to the reservoir.

Discovered in 1879, the field reached its all-time peak production of 20,000 barrels of oil per day in 1882 and its all-time low in 1912 with only 1,550 barrels per day. At this time the 46,500,000 barrels which had been produced, represented less than one third of the total oil produced to date* and about 18% of that estimated to have been in place originally.

Such a decline in production is normal in the solution-gas-drive type of oil field when the natural gas is produced and the energy which forces oil through the pores into the well bore is thus dissipated. This fact is first borne out when the well ceases to flow and must be pumped. Further natural energy dissipation reduces the volume of oil which can be pumped from the well until it becomes uneconomical to operate. Often a vacuum is pulled on the producing well to help increase production and prolong the inevitable natural end. Such a stage had been reached in the Allegheny field in 1912 when each well averaged only about $1/8$ - $1/10$ barrel of oil per day. In other words the primary recovery phase was completed and the stage set for secondary recovery.

RESTORATION OF ENERGY AND SECONDARY RECOVERY

Secondary recovery has been defined as the recovery by any method (natural flow or artificial lift) of those hydrocarbons which enter a well bore as a result of augmentation of the remaining natural reservoir energy after a reservoir has approached its economic limit of production by primary methods. If this rejuvenation takes place earlier it is most often called pressure maintenance and the division between the two is very indistinct. Usually secondary recovery is accomplished by the joint use of two or more well bores.

The first method of secondary recovery used was that of injection of gas and/or air, into one well, often combined with the use of a vacuum on the oil producing wells in order to further increase the pressure differential between input and producer. This procedure was later found to be more successful than waterflooding in the oil sands of western Pennsylvania, Ohio and West Virginia. Waterflooding was discovered by accident, prior to 1907, by the leaking of fresh water through faulty casing onto the oil sand of a depleted well.

The additional pressure thus put on the sand face caused an increase in oil production on nearby wells and, when recognized, started a flurry of purposely made "leaks" in the casing of other wells. From this random "conversion" of oil wells into water intake wells the process became refined by applying greater control to the amount and condition of water which could get onto the sand face. Coincident with this advance came definite patterns for the injection wells. Through the years this has developed from one injection well surrounded by producers, through the progressive line flood, to the pattern of 4 injection wells on the corners of a square and producer in the center, called the "five-spot". It is this pattern which is used almost exclusively in the Allegheny Field and the Bradford Field and which is the most economical and efficient for pattern type waterflooding.

* Total is 150,000,00 barrels to 1/1/57

FACTORS INFLUENCING WATERFLOOD

Of all the factors which affect waterflooding, uniformity is the most important and oil saturation next. Without the required degree of homogeneity, both horizontal and vertical, the oil cannot be removed efficiently or economically. Without sufficient oil content the process cannot make money, even if all oil is removed, so therefore it is useless.

GEOLOGICAL FACTORS

Geological factors play a most important part in determining the success of a waterflood. It is in their application to preliminary estimates and later operation that the geologist can be most helpful to management. The more important geological features which influence a waterflood in its planning and development stage are the thickness, depth, composition, shape and structure of the reservoir.

Thickness of the reservoir is important because the greater thickness means more reservoir volume. No overall minimum can be applied because of varying costs of development and operation and the price of oil. In the Allegany Field 8-10 feet of net pay thickness is the minimum that can be economically flooded at present.

Depth of the reservoir affects the cost of development and the pressures which can be used. Maximum depth at which a flood can be operated depends upon the estimated recoverable oil, the spacing of old wells and the cost and necessity of completing new ones or reworking old ones. Shallow depths limit the amount of pressure which can be used (empirically determined to be equivalent to about one pound per foot of depth) and may expose the formation to the deleterious effects of surface-connected joint planes or other fractures.

Composition of the rock determines whether it is primarily silica or carbonate rock. Sandstones are generally the most efficient waterflood medium, dolomites next and limestones last because of their relative uniformity of texture.

Shape of the reservoir may have a considerable bearing on the pattern of wells used, the spacing between them and their orientation. In large oil fields this is not so much a factor as it is in the small lense type of field, or in the "shoestring" sand bar field where the permeability is usually greater parallel to the long axis.

Structure of the reservoir is important, but critical only when severe faulting or folding has caused isolated production units or steep and variable dips which would dictate spacing and pattern adjustments.

Uniformity of the above features is certainly to be desired but is not nearly as critical as the uniformity of the geological factors which largely control the efficiency and operation of the flood, namely texture, mineral composition and shale partings.

Texture of the reservoir body is controlled by grain size, shape and arrangement. These in turn affect permeability and porosity and therefore not only the rate at which fluids can move through the reservoir, but also the volume that can be put in, the amount of oil that is left after primary recovery and the percent that can be moved by waterflood. Generally a fine, even textured sand will yield less primary and more secondary oil than a coarse textured reservoir. Grain size and arrangement, plus the amount and type of cementing material, also control pore diameter and distribution which are the most influential factors in determining the rate of fluid flow.

The full effect of mineral composition of the reservoir rock on the operation of a waterflood is not completely determined. We do know that the swelling of certain clay minerals in the presence of fresh water seriously impairs the rate of water

throughput. We suspect that changes in mineral content alter the wettability.

While shale partings are in a sense part of mineral composition, they are thought of here in the broader sense of a sedimentary condition which can isolate pay horizons from each other horizontally (lensing) or separate them vertically and thus act as a permeability barrier to any natural gravitational separation of water, oil and gas. While the shale of itself is not a deterrent and many operators prefer to find some shale barriers, the isolation of pay layers vertically and horizontally cannot be too great and still permit fluid movement from injection well to producer.

PHYSICAL AND CHEMICAL FACTORS

We find that many physical and chemical properties of the rock also warrant consideration in planning and conducting a waterflood. Oil, water and gas saturation are most important. Without enough oil no flood can be economical. With the required oil saturation and too high a relative water saturation perhaps only water will move. When gas saturation is too high dangerous by-passing and waste of water may occur. Effective permeability to water will vary as the relative saturation of the rock with water, oil and gas changes, thereby changing water injection rates.

Permeability and porosity of the pay and of the other formations exposed to water injection determine the rate of fluid thruput and the volume of fluid used respectively.

Wettability is actually a physical property of the rock, derived from a combination of geological and chemical factors. It is that property of a rock which renders the rock preferentially oil wet or water wet and determines if the formation will flood successfully.

Character of the natural oil and natural water are important. Each must be compatible with the injected fluid and the viscosity of the oil must not be too high. Allegheny crude oil is about 4-6 centipoise at a formation temperature of 68°F and is considered almost ideal.

DEVELOPMENT OF WATERFLOOD OIL PRODUCTION

After acquiring a waterflood prospect there is always information that would be desirable to have which would help determine the best method of operation that will produce the most oil economically, so the first well drilled on the prospect is usually cored and analyzed.

TESTING

There are three types of cores that can be taken. The diamond core, taken with rotary tools operating a diamond bit, cuts a solid section of the formation. It is the most expensive method but also allows a more complete analysis and it usually recovers all the formation.

Next preferred is the Baker core taken with a special bit operated on percussion type tools. The core taken is removed in "biscuits" which are large enough to run most analyses. The drawbacks to this type of coring are frequent loss of core and biscuits not large enough to run a complete analysis.

Chip coring, as the name implies, is a method of recovering fairly large chips of the producing formation. It is easy and inexpensive to take but requires special handling in the laboratory. Not all laboratory tests can be run on chip cores.

After the core is taken it is common practice to obtain an electric log of the well. This log, compared with the core, will give information that is very useful in well completion work and, when compared with electric logs of other wells on the lease

2
will afford a truer evaluation of changes in reservoir characteristics. The interpretation of electric logs is highly specialized work.

Core analyses will indicate the formation thickness, pay thickness, permeability, porosity, oil saturation, water saturation, and residual oil saturation after laboratory flooding. From this data accurate estimates of recoverable oil can be made, the most economic well spacing can be determined, the method of completing the wells can be decided and the general economics of the whole operation can be planned.

A typical core in this area would show perhaps eighteen feet of "pay" sand, thirteen percent porosity, five millidarcies permeability, forty-five percent oil saturation that on laboratory tests will waterflood down to a residual oil saturation of twenty-five percent. Connate water can be calculated and usually runs around twenty percent of pore volume.

DRILLING

The drilling of input and producing wells is identical. In this area the accepted practice is to drill a ten inch hole through the unconsolidated formations and set eight inch pipe. This averages 40' of depth. An eight inch hole is then drilled through all the ground water formations (from three to five hundred feet in this area). Six and one-quarter inch casing is set at this point and a six and one-quarter inch hole is then drilled to and through the producing formation to a point forty or fifty feet below it. Average total depth is 1500 feet. The "pay" formation drill cuttings are saved and can be compared with the electric log which is taken as soon as the hole has reached total depth. From the cuttings and electric log the shot is determined. Wells are shot in this area with liquid nitro-glycerin which is lowered into the hole in thin metal containers to a point opposite the producing formation. An average shot would use three quarts of nitro-glycerin per foot of producing formation. The shot is detonated by a "squib" containing two fused sticks of dynamite. The purpose of shooting a well is to break up or fracture the producing formation which greatly increases the effective well bore and therefore increases the rate at which the well can produce fluids or take injected water. Both injection and producing wells are shot. Up to this point both are completed in exactly the same manner.

COMPLETING

The equipping of an injection well consists of running tubing, usually two inch, on a packer which is set immediately above the producing formation. Approximately twenty sacks of cement are placed on top of the packer to hold it securely against the pressure that is to be applied. The tubing is then connected to a line which brings water from a pressure plant. Each well is equipped with a meter so that the amount of water being injected can be determined and controlled. See fig. 3 for diagram of a typical water injection well.

Producing wells, when completed to flow, are equipped in exactly the same manner. If they are to be pumped, a pump barrel is run on tubing to a position near the bottom of the hole. The pump plunger is run into the pump barrel on sucker rods which are used to activate it. These rods in turn are activated by single well jacks, or by jacks connected to a central power by surface rods. Single well jacks are in wide spread use where cheap electric power is available. See fig. 3 for diagram of a typical pumping oil well.

Water lines are buried below frost level to connect each injection well to the pressure plant. Separate oil and gas lines are laid to each producing well to connect them with the fluid gathering system. If oil wells are to be pumped from a central power surface rod lines are run from it to each well jack. If oil wells are pumped individually some form of fuel, electricity or gas, must be lead to each well.

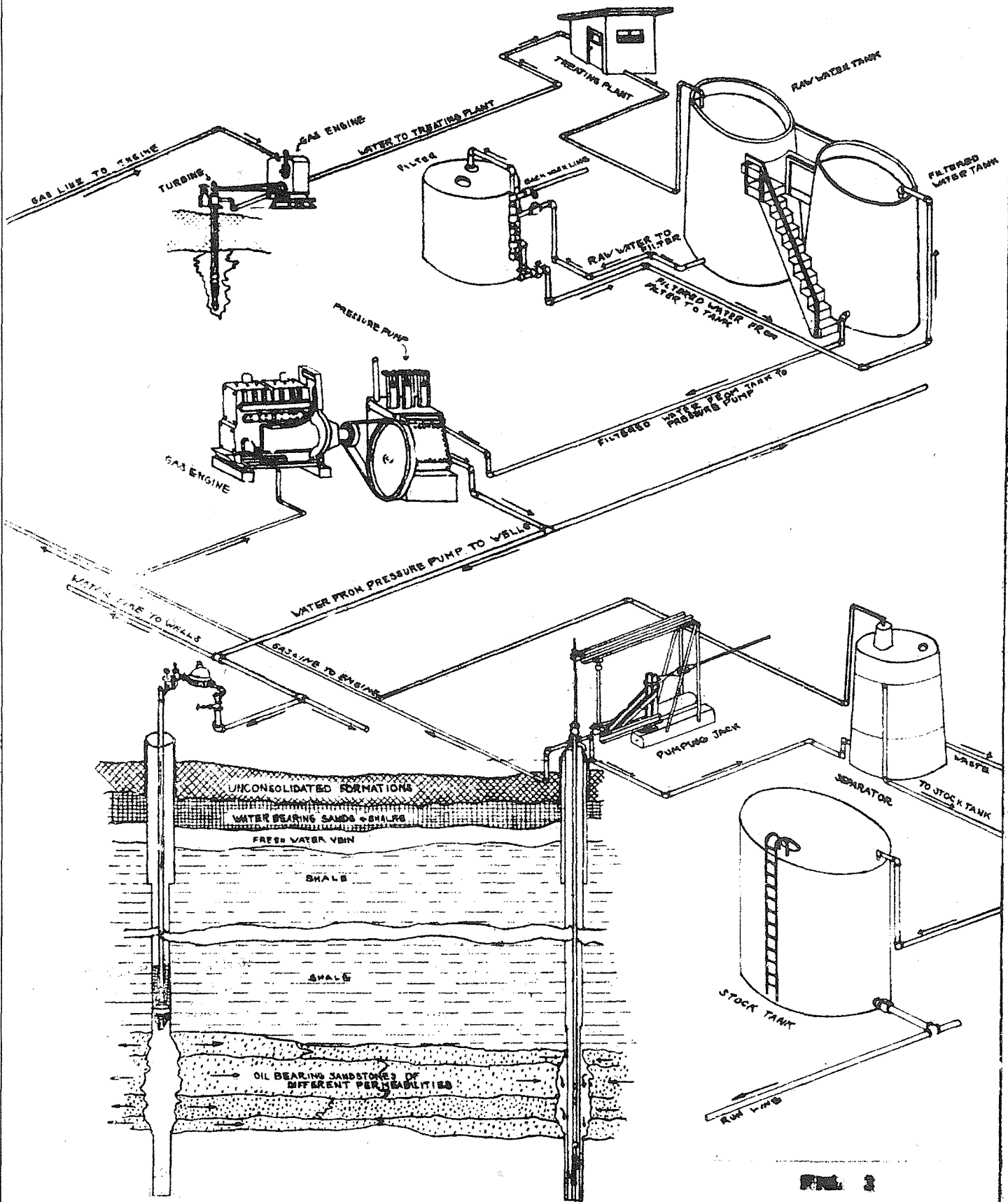

FIG. 2

1. AFTER DEVELOPMENT
COMPLETING

THE SLOAN AND ZOOK COMPANY
BRADFORD PA.

METHOD OF OIL RECOVERY BY WATER
FLOODING PROCESS IN
THE BRADFORD FIELD

MVBAM MAY 12, 1930
REVISED BRADLEY PRODUCING CO. JUNE 18, 1932

WATER WELL

OIL WELL

LEGEND

- GAS - []
- OIL - []
- WATER - []
- RAW - []
- FILTERED - []

This completes the development of the waterflood property and brings it to the operational stage of injecting water and producing oil. The detailed layout of a complete waterflood system can be seen in fig. 3. Development costs up to this point will average \$3000 per acre at the present time in the Allegany field.

PREPARATION AND INJECTION OF WATER

In order to properly waterflood an oil reservoir an adequate source of water must be found and equipment installed to put this water under pressure into the "pay" reservoir.

A good flood water should be clear and free from any foreign particles or bacterial growths. It should be neither corrosive nor scale-forming. The flood water should be compatible with the sand formation to avoid swelling of the clays, and with the formation water to avoid deposition and plugging of the sand.

SOURCE

The water used in this area comes mainly from gravel and rock formations. Gravel wells are found from 20 to 50 feet below the surface, while rock wells are found from 100 to 300 feet below the surface. The gravel water well requires more work in completion and will produce a higher quantity but lower quality water. The amount could range from 50 to 150 gallons per minute. The rock water wells are deeper and as a rule produce less but better water. Rate of production varies from 30 to 85 gallons per minute. Water from rock wells has a better chemical stability with no dissolved oxygen. The gravel water is chemically less stable and more corrosive than rock water.

Air lift jet pumps were used soon after the beginning of pressure flooding in 1930. Some of these are still in service, but due to the large amount of dissolved oxygen jetted into the water, turbines, submersible pumps and pumping jacks have taken their place. These later pumps produce oxygen free water and reduce pitting and corrosion.

TESTING

Mineral analysis is necessary to tell the characteristics of a water. Dissolved oxygen, pH and free carbon dioxide tests are run at sample location. Tests for the amount of sulfates, iron, manganese, alkalinities, chlorides, hardness, silica, calcium, magnesium and total solids are made in the laboratory. From this analysis can be calculated the amount of settling tankage that will be necessary before filtration and the chemical treatment required.

TREATMENT AND FILTRATION

Inorganic chemical treatment is usually added to the water as it enters the settling tanks or ponds. This treatment is used to coagulate the heavy minerals and prepare the water for filtration. The chemicals used are coagulants, caustic materials, chlorine or chlorine solutions. The caustic material used in this type of treatment will raise the pH to an 8.4 to 8.8 range from the average of 6.5 to 7.5 usually found in natural waters in this area. Chlorine residuals before filtration should be from 1.0 to 0.5 parts per million. After filtration they should range from 0.5 to 0.3 ppm. The chlorine will also act as a bactericide in this treatment.

Filters are used to remove the coagulated minerals, foreign particles and bacterial growths. Anthracite coal is used as the filter bed more often than sand and gravel because the density is lower and it requires lower backwash rates. The filter media is one foot of walnut size on bottom, one foot of hazel-nut size in the middle and one and a half feet of fine grade (similar to sugar grains) on top. The rate of filtering should not exceed 2½ gallons per minute per foot of area. Backwash rates for coal beds should be 6 to 9 gpm, sand and gravel 13 to 16 gpm per square foot. Filtered water

storage is provided in order to keep the plant running during backwash of filters and during the shut-downs and repair of low pressure equipment.

Organic treatment is also used usually after filtration to inhibit corrosiveness, sequester heavy minerals and lower the surface tension of the water. Many of the organic compounds also have bactericidal qualities. All of the above mentioned chemicals are fed by a constantly proportioning chemical feeder. The cost of the above treatment ranges from one to two mills per barrel of water.

INJECTING WATER

From the filtered water tank the water gravitates into the suction side of the triplex positive displacement pump. This pump produces the pressure used to inject the water into the tight, fine-grained sands. Leaving the pump the water travels through the distribution system until it reaches each injection well. The distribution system consists of a main line (usually under 4" diameter) with smaller sized laterals (1½"-2") running to the intake wells. The entire system is buried below the frost line. At the injection well a barrel-registering meter is used, similar to the home water meter. Typical water well surface connections and equipment can be seen in fig. 3.

When water is started into a new injection well pressure is gradually raised for a few weeks before full line pressure is used. The rate of injection may be high at first until partial fill-up of the reservoir is obtained. The steady rate of an injection well will average one-half to one barrel of water per day per foot of sand. If pressures are raised too rapidly at the start of injection, or are carried too high at any time, a condition of "break-through" or "pressure-parting" may occur. This critical pressure seems to average about one pound of sand face pressure per foot of depth. We feel this could be caused by the lifting of layers of shale which may be above, below, or within the sand formation. It may also be vertical fracture along the zones of joint plane weakness. If a well is shut off immediately and left idle for several days this may correct the "break-through". Otherwise selective plugging agents can be injected into the formation break to plug off the flow rate in this section.

Over the 15 year life of an average Allegheny field waterflood an injection well will take about 75,000 bbls. of water. This amount of water has gone into an area of 2½ acres (330' square in an average five-spot). If we assume that the recoverable oil from the average five-spot will be 7,500 bbls., there will be 10 bbls. of water injected for each bbl. of oil produced. As the cost of treating and pressuring the water for injection will average 1½ cents per barrel we thus have a total water cost of about 15 cents for every barrel of oil produced.

PRODUCTION OF OIL

The production of crude oil in the Allegheny field involves lifting the fluid from the producing sand in the well bore to the surface of the ground. This lifting is accomplished either by flowing or pumping the well. Sand characteristics, time and economics involved determine which method shall be used in producing the oil well.

The flowing method uses the energy of the water drive to force the oil and water to the surface through the tubing.

In the Allegheny field primarily two different means are used in pumping wells, that is the individual well jack and the Oklahoma style jack pumped by a central power. The main difference in these two methods is that the individual well jack is a unit complete in itself with a motor to supply power to the jack for lifting the rods and bottom hole equipment. The power to the Oklahoma style jack is supplied by a cable or rod line from the eccentric of the central power.

TYPICAL SEPARATOR AS USED
IN ALLEGANY OIL FIELD
Fig. 4

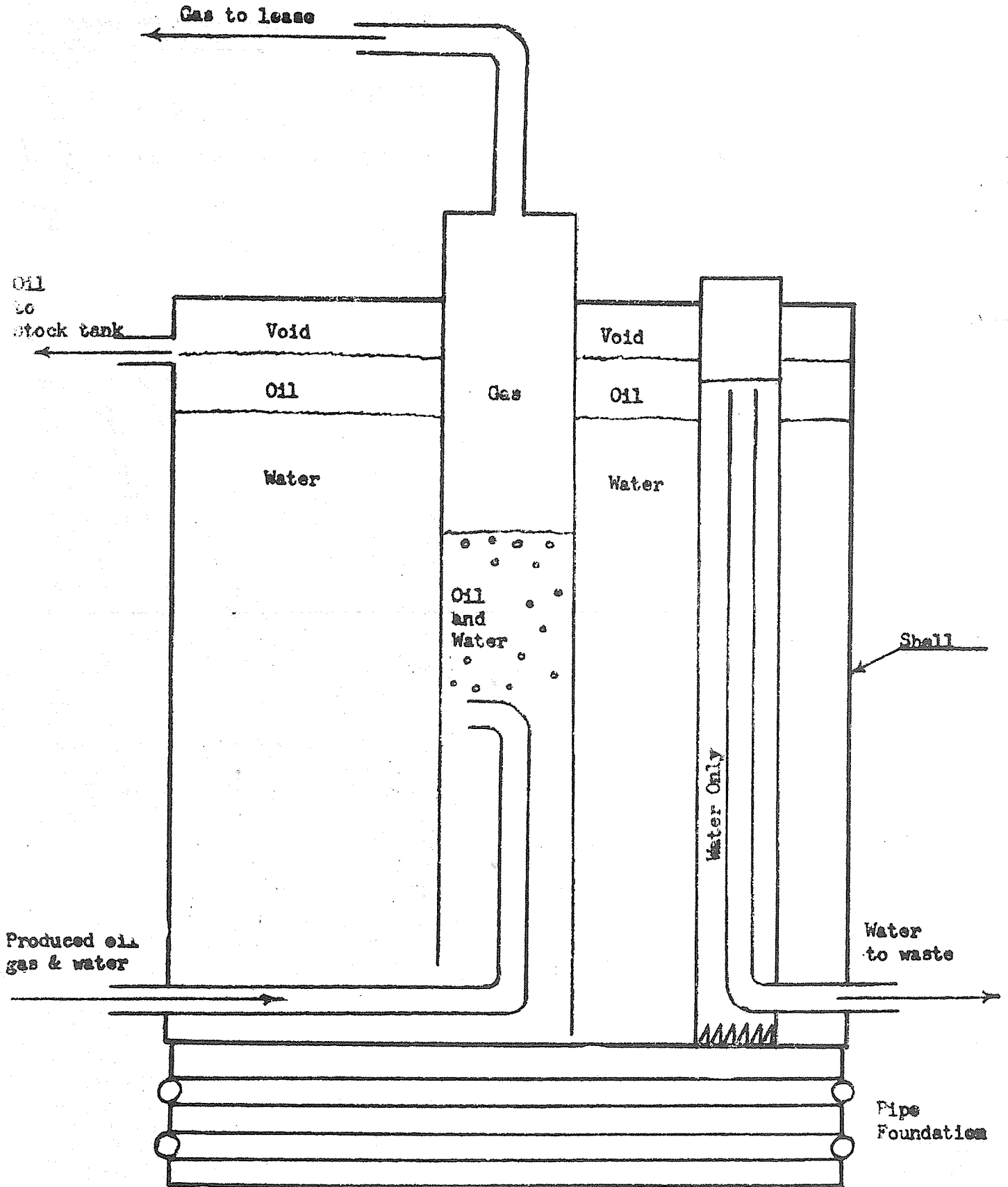

Two different types of central powers are in use today, the gear power and the bandwheel power. The gear power uses a gear and pinion powered from the engine by a belt to motivate the eccentric whereas the bandwheel power uses a horizontal band wheel powered by a belt running from the engine to motivate the eccentric.

Generally about 25 wells are pumped off of one central power. About four barrels of fluid per hour can be pumped from each well. Since this is normally more than will flow into the well bore it is not necessary to pump all the wells simultaneously, and the pumping times of the individual wells may be staggered throughout the pumping period.

At the beginning of production in a waterflood only oil and gas are produced. At peak oil production water will generally appear in the producing well. After peak oil production the same amount of fluid is produced but the oil keeps decreasing and water increasing until the water-oil ratio becomes excessive. When this condition exists the lease becomes unprofitable to operate and is abandoned.

The gas which collects in the annular space between the casing and tubing is taken off at the casing head of the well and piped around the lease where it is used to run engines and furnish heat. The oil and water is pumped into pipe lines generally of 2" diameter which connect several wells to a separator. Since there is little emulsion in the fluids produced they can be separated by gravity at the separator as shown in fig. 4. From the separator the oil is piped into stock tanks and the water is run to waste. Gas from the separator is returned into the gas line system supplying engines and heat.

The standard stock tank in this field will hold about 140 barrels, being 10' high with a diameter of 10'. After a tank is full a gauger from the refinery measures the amount of oil in the tank and allows it to enter the pipe line leading to the refinery. Oil in the stock tanks must be at a minimum of 75°F, or must be heated to that temperature before the gauger will run the oil out to the refinery.

Operating costs vary depending on the size of the lease, the terrain, the characteristics of the fluid produced, the depth of the oil sand and the method by which the oil is produced. Generally we assume that over the producing life of a lease it costs \$1.50 per barrel to pump the oil and \$1.00 per barrel to flow it.

ECONOMICS OF WATERFLOOD OIL PRODUCTION

The oil producer has only two basic problems. One is the acquisition of reserves. Since the production of oil is a "wasting" operation, the only way a producer can stay in business is to acquire at least as much oil as he produces. He may acquire reserves in several ways. He can explore and develop primary reserves. He can purchase known reserves, or he can acquire reserves that can be recovered by special techniques such as waterflooding is practiced in the oil fields of New York.

The other problem the producer must solve if he is to remain in business is to produce his oil at a profit. This requires the use of efficient development and operating practices.

In acquiring waterflood reserves, a producer may purchase the "Fee" interests, all of the rights to the land and minerals. He may acquire only the mineral rights plus the right to use the surface for the development of the minerals. He may acquire a lease which gives him the exclusive right to prospect for and produce minerals from a property.

In acquiring fee interests or mineral rights the producer owns all the oil and gas he produces, but has the cost of acquisition in obtaining these rights. Where he ac-

quires a lease (working interest), the producer bears the entire cost of producing all of the oil and the basic mineral owner usually reserves one-eighth of the gross oil produced (basic royalty), saved and marketed for himself at no cost of production. This type of acquisition has the advantage to the producer of requiring relatively small amounts of initial cash, and it also reduces his risk capital.

Most secondary reserves are held by producers who have produced, or are in the process of producing, the primary reserves. Usually there is a considerable amount of information available which enables the waterflood producer to more accurately evaluate the property as a secondary prospect. This information decreases to some extent the risk he must take.

ACQUISITION OF RESERVES

The oil producer deals in calculated risks. His success or failure is determined by his accuracy in determining what his risks are. If the risks are high, as in primary exploration, he must have the possibility of getting his investment back several times before he can justify a "wildcat" well.

He may wish to spread his risk. This he does in many ways, by selling part of his working interest, by selling an overriding royalty on his share of the production or by a deal with a drilling contractor who will drill a well for an interest in the property. He may get "dry-hole" money from people who have interests in nearby properties and who are willing to pay some part of the well costs, if it is "dry", for a test in the area. These are only a few of the myriad types of deals used in the industry to spread the risk.

Royalties themselves are dealt frequently. Royalties are sold by people who prefer a known amount of cash in hand to an indefinite amount to be produced at an indefinite rate in the future. The three significant factors governing royalty values are the reserves attributed to the royalty, the price of the oil and the rate of production.

The producer acquiring secondary reserves attempts to accurately estimate the number of barrels a property will produce. From this he subtracts the amount that he must produce to the royalty or other interests. The balance is the production he will have left to generate his income. He must then estimate the price he is going to receive for his production. From this information he can determine what his gross income will be. He then estimates the time it will take him to produce this income and the costs of developing and operating the property.

The sum of these costs subtracted from working interest income gives him a balance. From this balance he must determine how much he can pay for the property, and still leave him a reasonable return on his investment for profit.

As an example let us use the costs and figures mentioned in the foregoing pages and assume the present price for crude oil in the Allegany field of \$4.88 per barrel. It will cost \$1.00 to develop the property, 15 cents to inject the required water and \$1.50 to pump it for every barrel produced. The royalty owner will get 61 cents for every barrel (1/8 royalty). If we assume 50 cents per barrel is paid to purchase the property, the operator will have only \$1.12 per barrel for a return on his investment over a 15 year period.

This is a very brief summary of the industry economics. There are hundreds of variations in the types of deals the producer can make. The prime considerations are always the risk involved, the return he can expect on his investment, and the time it will take him to produce his income.

From the small increases in oil production which were first noticed around "leaking casing" or "purposely dumped" wells in Pennsylvania about 1907, waterflooding has grown to be a scientifically engineered, production practice accounting for over 5% of the nation's 7,800,000 barrels of oil produced per day.

From Pennsylvania the method spread to New York in 1912. Increased production from waterfloods was noted in Kansas as early as 1916, Illinois in 1924, North Texas in 1930 and Oklahoma in 1931. California started waterflooding in 1946 and experimental tests were initiated in four fields in Michigan in 1956.

At the present time 19 states of the 27 which produce oil have recognized waterflood production and in 7 of these it is of major value. Ninety percent of all the oil produced in the Pennsylvania Grade oil fields of New York and Pennsylvania (including parts of Ohio, West Virginia and Kentucky) in the last 30 years has been by waterflood. It accounts for approximately 30% of the oil presently produced in Illinois and Indiana, 14% of Oklahoma's production and 13% of Kansas'. In Texas waterflood production is only 3% of the state's total, but is the highest of any of the states at about 90,000 barrels per day.

Where waterflooding is feasible it will generally produce, as a secondary recovery process, as much oil as was produced by primary means. When it is initiated before the end of the primary recovery stage it can more than double the expected primary recovery. A fine example of this is the well known East Texas field from which initially the recovery was estimated to be about 40%. The field is presently producing about 200,000 barrels per day, and is estimated to yield an ultimate total of 6 billion barrels, 90% of the oil originally in place, because of water injection since 1938.

There has accordingly been an increasing amount of application of injected water to the newer oil fields before they are primarily depleted, thus accomplishing a higher efficiency of production and shortening the time required to produce it.

It has been predicted that 25% of the country's oil production will come from waterflooding by 1980.*

*This and other statistical data above are taken primarily from articles by Albert E. Sweeney, Jr. of the Interstate Oil Compact Commission, and published in the Oil and Gas Journal of 3/26/56, p. 73; the Petroleum Engineer of May 1956, p. B-120. Also from "Secondary Recovery of Oil in the U. S." (See bibliography)

IX - REFINING A BARREL OF PENNSYLVANIA GRADE CRUDE
PRODUCED IN ALLEGANY COUNTY, NEW YORK

by Fred B. Emerson, Sinclair Refining Co.

The Pennsylvania Grade crude, which is received at the Refinery storage as it comes from the well, is a complex mixture containing hundreds of hydrocarbons ranging from the simplest compounds of gases, which are absorbed in the liquid components, to heavy resins.

The first step in converting crude oil into products suitable for consumer use is the separation of various components by a process known as fractional distillation. In this process crude is pumped from tank farm storage through a coil heater. As the oil passes through the coils, varying degrees of temperature are applied which causes the oil partially to vaporize in very much the same manner as boiling water in a kettle.

The mixture of hot vapors and liquid discharges into a fractionating tower, the vapors rising through a series of especially designed trays which are located at intervals from close to the bottom of the tower to near the top. Each tray is perforated by a number of holes and over each hole is a small pipe 2" to 4" high, which is fitted with a "bubble cap". The lower edges of these caps are immersed in the condensed liquid collected on the tray which is designed to prevent the liquid from escaping through the perforations, while forcing the rising vapors to enter and flow, or "bubble", in intimate contact with the pool of liquid on each tray.

These are called "bubbletrays". Each is fitted with "down-comer" pipes, alternating trays having two pipes, one on each side, while the others have a single pipe set in the middle. These pipes extend from about 4" above the bottom of the tray downward to very nearly the bottom of the tray below. Their design prevents the passage of rising vapors but allows the free flow of down moving liquids. The length of the upward extension of these pipes governs the depth of liquid accumulation on the trays, and the downward movement of liquid is arrested until enough condensation is collected to cause an overflow to the tray below.

Since the temperature within the tower is progressively lower as the vapor ascends, a certain amount of condensation takes place at different tray levels. As the vapors condense and the liquid accumulates on each tray, it spills over through the down-comer pipe to the tray below, where it is again partly vaporized. As these vapors rise and pass through the liquids on the bubble tray above, they strip out those lighter portions of vapor that have been entrapped in the liquid through which they are passing and carry them on to trays above where they are either condensed, pass on to still higher trays, or, upon rising to the top, escape into the vapor line.

It will be noted that the vapor travels in cycles, vaporizing over and over until it finally is reformed into those portions of crude oil best suited as a base stock for producing the many refined petroleum products in demand today. At this stage of the distillation process, these portions are drawn from certain of the fractionating tower bubbletrays at predetermined levels, cooled and passed on for further refining. (See Chart 2). The lightest vapors do not condense, but rise immediately through the trays and pass through the vapor line to a condenser. This process is carried on in one continuous operation.

In the condenser, a major portion of the vapor is liquefied, becoming raw gasoline, and with the remaining fixed gases, passes into a separator. These fixed gases are drawn from the top of the separator and the liquefiable portions are made into light gasoline and the dry gas burned for Plant fuel. The raw gasoline is charged to the Cracking Still and goes through a reforming operation to raise the octane so that it is suitable for blending into base gasoline for automotive use.

We will now consider the various cuts as they come from the fractionating tower. The top side stream taken from the tower is raw naphtha. This liquid goes through a cooler and then is chemically treated into solvent, a product of many uses. This solvent is used for dry cleaning and also the manufacture of paints and varnish and has many other uses.

The next two cuts, kerosine and light gas oil, receive practically the same treatment as the raw naphtha. The kerosine is used as fuel for heating, lighting and cooking purposes. Light gas oil is blended with kerosine and sold for home heating and for diesel fuel.

Then comes the gas oil fraction. This portion of the crude is either catalytically or thermally cracked at high temperature, thus splitting and rearranging the heavier molecules into desirable components in the gasoline boiling range. The fixed gases from this operation are taken to a Polymerization Plant, where it is processed by intimate contact with certain catalysts into high octane gasoline blending stock. The residue from this cracking process is a heavy fuel oil used for fuel by industrial plants.

The next portion of the crude oil from the fractionating tower is known as lubricating oil distillates. These oils are chemically or solvent treated to remove certain resinous and carbonaceous and unstable unsaturates which are undesirable in the finished Pennsylvania lubricating oil. The oil is then dewaxed so that the finished oil will flow freely at temperatures below 0°F. The final process is primarily a decolorizing operation. The lubricating oil is brought into intimate contact with certain adsorption clays at elevated temperatures and decolorized and stabilized for a finished, high grade, Pennsylvania lubricating oil.

The paraffin wax that has been removed from the oil during the dewaxing operation is further refined to lower the oil content and decolorized by filtering through a bed of filter clay at elevated temperatures. This paraffin wax is used for making candles and bread wrap, and has many uses too numberable to mention.

The last portion of the crude oil to be drawn off is known as steam refined cylinder oil and is used for making various grades of steam cylinder oils for lubricating steam pumps and steam locomotives. This residual lubricating oil stock is treated in much the same manner as the lube distillate fraction. The difference in the finished products is in their viscosity, the lube distillate producing a light body, low viscosity lubricating oil, and the residual lube stock a heavy body, high viscosity lubricating oil. The wax removed from the residual lube stock is micro-crystalline in nature and is decolorized and deodorized much the same as the crystalline paraffin wax. The micro-crystalline wax has many uses, one very important use is for food wrap in the frozen food industry. The outstanding physical characteristic of micro-crystalline wax is its ability to not become brittle at the sub zero temperatures at which frozen foods are stored.

The light lubricating oils refined from lube distillate and the heavy lubricating oils refined from the residual lube stock are moved into tankage at the Compounding and Packaging Plant. At this point the light and heavy lubricating oils are blended together in varying percentages to produce different grades of lubricating oils. The blended oils are then compounded with additives into exceptionally high quality specialized lubricants.

The refining of the Pennsylvania Grade crude oil produced in Allegany County is essentially for the high grade lubricating oil obtained from this type crude. It is desirable to yield as much high grade lubricants from the crude as possible with the hope that it can be marketed at a price that gives a fair margin of profit. However, the oil refiner is at the mercy of the market and therefore has to adjust his operations to meet the demand. A refinery is a very flexible manufacturing plant and can control its output, within limits, of course, to meet this condition. It is unfortunate, however,

that some operations are not economically sound and a refiner, especially a small one, must be constantly bettering his operations so as to yield as high a percentage as possible of those products that give the best returns on his investment. The alternate use for these higher valued products such as lubricants and waxes is cracking them into gasoline and industrial fuels. This operation is not basically sound as a premium is paid for Pennsylvania Crude Oil because of this high grade lubricating fraction contained in the crude.

The weather is another factor that greatly affects a refiner's market, but we can do something about it. Gasoline consumption decreases in the winter and heating oil demand increases, and we adjust our operations to meet this change by blending Cracking Still charge stock into fuel oils, thereby reducing gasoline production and increasing heating oil production.

It can be seen that the yield from a barrel of Allegany County crude oil varies within certain limits with conditions. However, a typical refinery yield from a barrel of Allegany crude oil, as shown on page 272 of "Empire Oil" is:

<u>Product</u>	<u>Gallons</u>
Gasoline	12.5
Distillate Fuels	9.0
Lubricating Oils	11.5
Wax	1.0
Residual Fuel	7.5
Loss in Refining	<u>0.5</u>
Total	42.0

The markets supplied with the high grade lubricants and waxes manufactured from Allegany crude oil are world wide. Railroads consume large quantities of lubricants and diesel fuel refined from Allegany County crude oil. The service stations dispense packaged and branded oils direct to the motoring public. Large quantities of paraffin wax are exported for use in the candle making industries. The micro-crystalline wax readily finds a market both domestic and foreign. It is used extensively in the frozen food industry for package wrap due to its ability to be chilled to sub zero temperatures without becoming brittle and chipping off the package when handled. The gasoline, heating oils, and industrial fuel oils are sold in nearby markets, say within a hundred mile radius.

The prices that the refiner receives for finished products have not kept pace with the prices that he pays for charge stocks and other operating costs. This reduces his potential per barrel of crude oil run, and the small refiner (all refineries processing Pennsylvania Grade crude oil are comparatively small) is in the position of diminishing returns on his investment. The prices obtained by the refiner for high grade Pennsylvania lubricants are, in many cases, less than were received a decade ago. While commodities other than petroleum have increased greatly, petroleum prices have advanced moderately. Even the price paid at the service station for gasoline is little more than that paid ten years ago (excluding taxes paid by the consumer at the pump). The requirements of both fuel and lubricants for the modern high compression engine used in today's automobile have been met by the refiner through the investment of huge sums of money for both research and equipment.

54
 X - TRIPS A-1 AND A-2 GEOLOGICAL OUTCROPS IN WELLSVILLE AREA

by W. L. Kreidler, N.Y.S. Geological Survey

Miles

- 0.0 9:00 A.M. Wellsville Rod & Gun Club, proceed east on black top.
 0.6 Junction of Route 19, turn right (south). The Wellsville crops out at the base of the hills to the east which are capped by Germania or basal Cattaraugus.
 1.65 Stannards Corners straight ahead.
 2.25 Turn right (west) on black top.
 2.50 After crossing Genesee River bridge, make a sharp left turn (south).
 2.90 Railroad crossing.
 3.00 Left turn (south).
 3.10 Right turn (west).
 3.55 9:07 A.M. STOP NO. 1 Hinsdale outcrop in road cut along Fords Brook.
 This is a 20 minute stop. (Sta. 2 on Map 2)
- Description:
 Top - 7' Hinsdale - interbedded gray micaceous siltstones 1" to 4" in thickness and gray shales; contain loose sponge spicules, Prismodictya sp. and Cyrtospirifer disjunctus.
 Base - 5' Wellsville - interbedded 1" to 4" dark purple siltstones and shales.
- 3.55 9:27 A.M. Leave Hinsdale outcrop, proceed west on gravel road.
 3.90 Outcrop on left across creek.
 4.20 Straight ahead.
 4.50 Oil wells in Fords Brook pool on left.
 4.75 Paved road.
 5.50 Turn right (north) at crossroad.
 6.20 Straight ahead.
 8.30 Sinclair tank farm on left.
 8.50 Wellsville village limit.
 8.70 Turn left (north) on South Brooklyn Avenue
 9.10 Stop light, straight ahead. (Pink house on southwest corner belongs to Mr. Hall, a Devonian fossil collector.)
 9.30 Stop light, straight ahead.
 9.70 Turn right (north) at end of street.
 9.95 Turn right (north) on Highland Avenue.
 10.30 Turn right (east) on Route 17 at Airport.
 10.55 Cross Genesee River and turn left (north) at blinker light onto Route 19. (At northeast end of Genesee River bridge test hole encountered 125' of glacial deposits.)
 12.2 Glacial and river terraces on right.
 13.6 Glacial and river terraces on left and Scio oil pool, on right, across railroad tracks. Top of producing sand is at a depth of 290'.
 14.15 Cross railroad tracks.
 14.45 Blinker light at Scio, turn right (east) onto county road #10.
 15.15 Machias formation outcrops on right across Vandermark Creek.
 16.85 10:00 A.M. STOP NO. 2 Cuba and Machias outcrop.
 This is a 45 minute stop. (Sta. 3 on Map 2).

Description:

Top - (the upper portion is accessible only with great difficulty and therefore the data for these upper units is taken directly from the Wellsville Bulletin)

- Top - 20' irregularly bedded buff sandstone
 12' fissile olive-gray argillaceous shale
 13' buff siltstone and sandstone containing numerous Tylothyris mesacostalis

- 2' massive buff sandstone
- 5' interbedded buff sandstone and siltstone
- 1½' massive buff sandstone (base of Cuba)
- 12' interbedded gray shale and thin gray siltstone (top of Machias)
- 1' fossiliferous gray siltstone
- 10' mostly gray argillaceous shale with a few thin gray siltstones
- 1½' medium light gray siltstone containing coquinites of Cyrtospirifer disjunctus
- 6' fissile medium gray shale with limonitic stain
- 2' gray siltstone containing coquinites of Cyrtospirifer disjunctus
- 15' mostly medium gray argillaceous shale showing limonitic stain with a few interbedded 1" to 1' gray siltstone containing crinoid stems

road level - 20' mostly medium gray shale with a few interbedded 1" to 2" gray siltstone

Base - 6' interbedded medium gray shale and gray 1" to 2" siltstones
(The lower two units are exposed in the creek bed below road level.)

- 16.85 10:45 A.M. Leave Cuba and Machias outcrop, proceed east.
- 17.60 Turn right (south) on gravel road.
- 19.10 Madison Hill oil pool.
- 19.20 Turn right (west).
- 21.50 Wellsville village limit.
- 21.70 Turn right (north) on Pearl Street.
- 21.75 Bear left, down hill.
- 21.85 Turn right (north) on Scott Avenue.
- 22.50 Turn left (west) on Farnum.
- 22.55 11:02 STOP NO. 3. Wellsville outcrop in stream bed about 100 yards north of street.

This is a 45 minute stop (Sta. 1 on Map 2)

Description:

- Top - 1' medium light gray 2" to 4" siltstone
- 7' olive gray shale with limonitic stain
- 12' concealed
- 2' medium light gray shaly siltstones and shales containing coquinites of crinoid stems; also present are Chonetes sp., Productella sp. and Cyrtospirifer disjunctus
- 2' medium light gray 1" to 6" siltstone containing Cyrtospirifer disjunctus
- 4' concealed
- 5' interbedded olive gray shale and medium light gray thin to 2" siltstones; contain crinoid stems, Chonetes sp. and Cyrtospirifer disjunctus
- 3' medium light gray 1" to 4" siltstones containing coquinites of crinoid stems and Cyrtospirifer disjunctus
- 15' olive gray shale with a limonitic stain and only a very few interbedded thin gray siltstones
- 1' gray fossiliferous coquinites of crinoid stems and Cyrtospirifer disjunctus

base - 5' medium light gray thin to 3" siltstones containing flattened concretions ("storm rollers") up to 3' in diameter

- 22.55 11:47 A.M. Leave Wellsville outcrop, proceed west.
- 22.60 Turn left (south) on Farnum Street.
- 23.10 Cross Erie R R Tracks.
- 23.25 Turn left (south) on North Main Street.
- 23.55 Turn right (southeast) at stop light onto East Pearl Street.
- 23.65 Cross Genesee River.
- 23.80 Stop sign, bear left.
- 23.95 Stop light, straight ahead (south).
- 24.60 Sinclair Refinery on left of road (County Route #44).
- 25.30 Turn left (east) and cross railroad tracks and Genesee River.
- 25.45 Turn right (south) into driveway of Wellsville Rod & Gun Club.

X - TRIPS B-1 AND B-2 HARRISON VALLEY ORISKANY GAS STORAGE FIELD
by G. C. Borland, N.Y.St. Nat. Gas Corp.

Miles

- 0.0 9:00 A.M. Leave WR&G Club with right turn to east and cross Genesee River flood plain.
- 0.6 Turn right at Shorts Service Station onto Rt. 19 and continue south along east side of Genesee River Valley on Rt. 19.
- 2.1 Sand bank on left is in glacial terrace material.
- 3.2 On glacial lake or stream terrace on East side of Genesee valley. Stream cut in opposite side of river valley about 1 mile ahead and on right is old stream channel cut when glacial lake drained this way into the Allegheny River watershed. Present Mississippi River-Great Lakes watershed divide is about 1 mile up this valley West of Genesee River.
- 4.8 Small gravel and sand quarry on right in glacial terrace material.
- 8.6 Cross Pennsylvania State Line. N. Y. 19 becomes Pa. 449.
- 9.2 Straight ahead in Genesee, Pa., where Rt. 449 goes right. Bear right on curve just beyond. Pass Genesee school on right.
- 10.1 Straight ahead and up hill out of main Genesee River Valley.
- 12.3 Cross cleared right-of-way of New York State Natural Gas Corporation's main transmission line from Sabinsville Field station to State Line Field Station. Right of way leads off to right at angle.
- 15.9 Straight ahead at Bingham Center 4 corners.
- 16.7 Left onto dirt. Hill top straight ahead is drainage divide between Great Lakes and Atlantic Coast water sheds. Elevation approximately 2200'.
- 17.1 Left and right bends in road.
- 18.3 Straight ahead. Chemung surface outcrop evidence. Catskill on scattered hill tops.
Note slightly reddish color of stones in fence rubble and stone piles on these hill tops. These are predominately from sandy formations in the Catskill (Cattaraugus).
- 19.0 Gas storage well on right is the Ida Scoville #1 at northwest edge of Harrison Oriskany sand gas field. Oriskany is at 5201' depth.
- 19.3 Straight ahead.
- 19.4 Left - Catskill evidence on left at top of hill.
- 19.6 Courtright storage well on left. Surface elevation 2225', top of Oriskany at 5129' in well.
- 19.9 Bear right at intersection. Glacial material on left. Terminal moraine of glaciers is about 10 miles south of this locale.
- 20.1 No. 2 Schofield storage well.
- 20.4 STOP 1 - New York State Natural Gas Corporation's Harrison Compressor Station, used solely for the storage of natural gas from Texas and the South in this previously depleted Oriskany sand gas field. Plant Engineer's house and Schofield #3 storage well on left side of road. Park on right side of road next to fence. (see fig. 5). ABSOLUTELY NO SMOKING INSIDE LIMITS OF FENCE.

11:30 A.M. The tour through the plant and "blowing off" the well will be completed about now. Those people leaving from this area can check their present location by looking at sketch in Chapt. VII, p.38

ANDREW SCHOFIELD WELL

PARK CARS HERE

PARK

R. Schofield Well

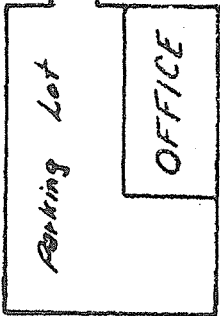

AUXILIARY BLDG.

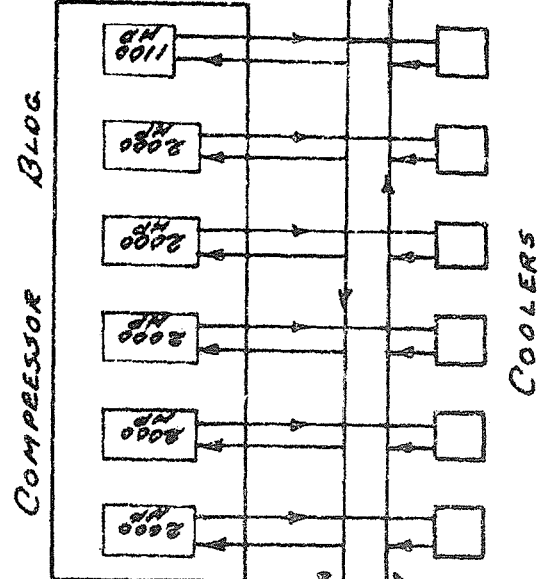
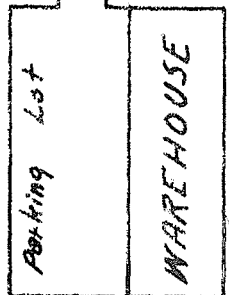

COMPRESSOR BLDG.

COOLERS

SUCTION

DISCHARGE

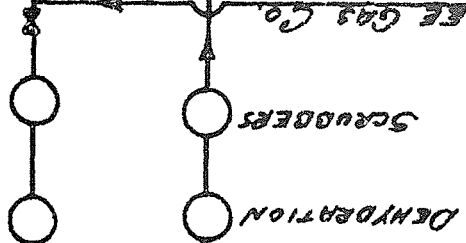

SCRAPEERS

DEHYDRATION

TENNESSEE GAS CO.

NK 5 N G CORP.

HARRISON VALLEY COMPRESSOR STATION

Fig. 5

X - TRIP D OIL FIELDS AND WELL SHOOTING
by W. H. Young, Jr., Bradley Prod. Corp.

MILES

- 0.0 1:30 P.M. Leave WR&G Club with right turn to east and cross Genesee River flood plain.
- 0.5 Turn right at Shorts Service Station onto Rt. 19 and south along east side of Genesee River Valley.
- 1.1 Incline is down off of old Genesee River glacial terrace.
- 1.6 Straight through Stannards where Rt. 248 goes left.
- 2.0 Sand and gravel in left bank is at base of old glacial lake terrace deposits.
- 2.2 Turn right. Sinclair Refining Co. station in distance on right before crossing river pumps oil from Fords Brook field to Wellsville Refinery.
- 2.5 Turn left immediately after crossing Genesee River.
- 3.0 Turn left at T intersection - Elevation is 1548'.
- 3.1 Turn right and approach west edge of Genesee River flood plain, going through Shady Brook Glen of Fords Brook. 3" pipe line running along left side of road carries all oil from Fords Brook field to Sinclair refinery. Rocks in Glen are Hinsdale and Wellsville (see Stop 1, Trip A-1) .
- 4.2 Turn left into South Branch Fords Brook.
- 4.8 First few oil wells at extreme NE edge of Fords Brook field.
- 5.3 Cross cleared right of way (visible to left, up hill) of 14" and 20" diameter lines carrying gas from Pennsylvania and New York Oriskany gas fields to Rochester. Lines owned by New York State Natural Gas Corporation.
- 5.5 North edge of Fords Brook oil field.
- 5.9 1:50 P.M. STOP NO. 1 Thornton Co. Warfield pressure plant. See water supply and injection wells, treating, mixing, filtering, pressuring and measuring of water and the flowing of oil wells for the water flood process of secondary recovery of oil. ABSOLUTELY NO SMOKING OR OPEN FIRE PERMITTED while away from cars. (see fig. 6)
- For next 0.3 - Boxes over water injection wells can be seen either side of road.
- 6.7 Turn left.
- 7.2 Turn left at fork and proceed up hill on dirt road.
- 7.5 Turn left and proceed up very steep hill. On other side of hill road parallels a line of water injection wells (on right) with a different type of cover box.
- 8.0 3:20 P.M. STOP NO. 2 Bradley Producing Corporation Wesche property. See pumping power, pumping and flowing oil wells, separator, stock tanks and gas saver used in oil recovery by waterflooding. ABSOLUTELY NO SMOKING OR OPEN FIRE PERMITTED in area of this stop. (see fig. 7)
- 4:30 P.M. Proceed on foot to see a well "shot" on the Bradley Producing Corporation Apco property about 1/4 mile east of STOP 2.
- 5.30 P.M. Return to WR&G Club.

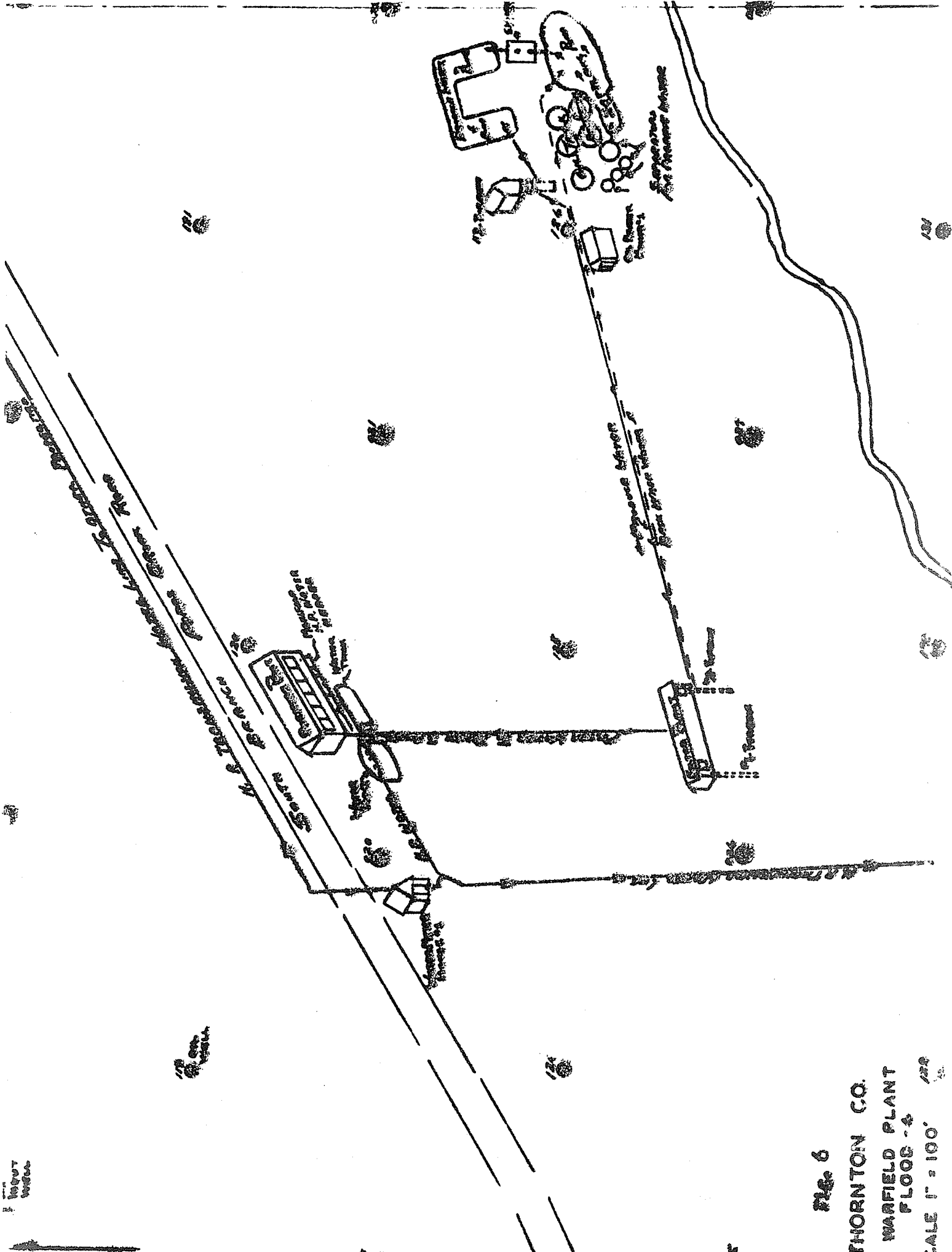

Fig. 6
THORNTON CO.
WARFIELD PLANT
FLOOR - 4
SCALE 1" = 100'

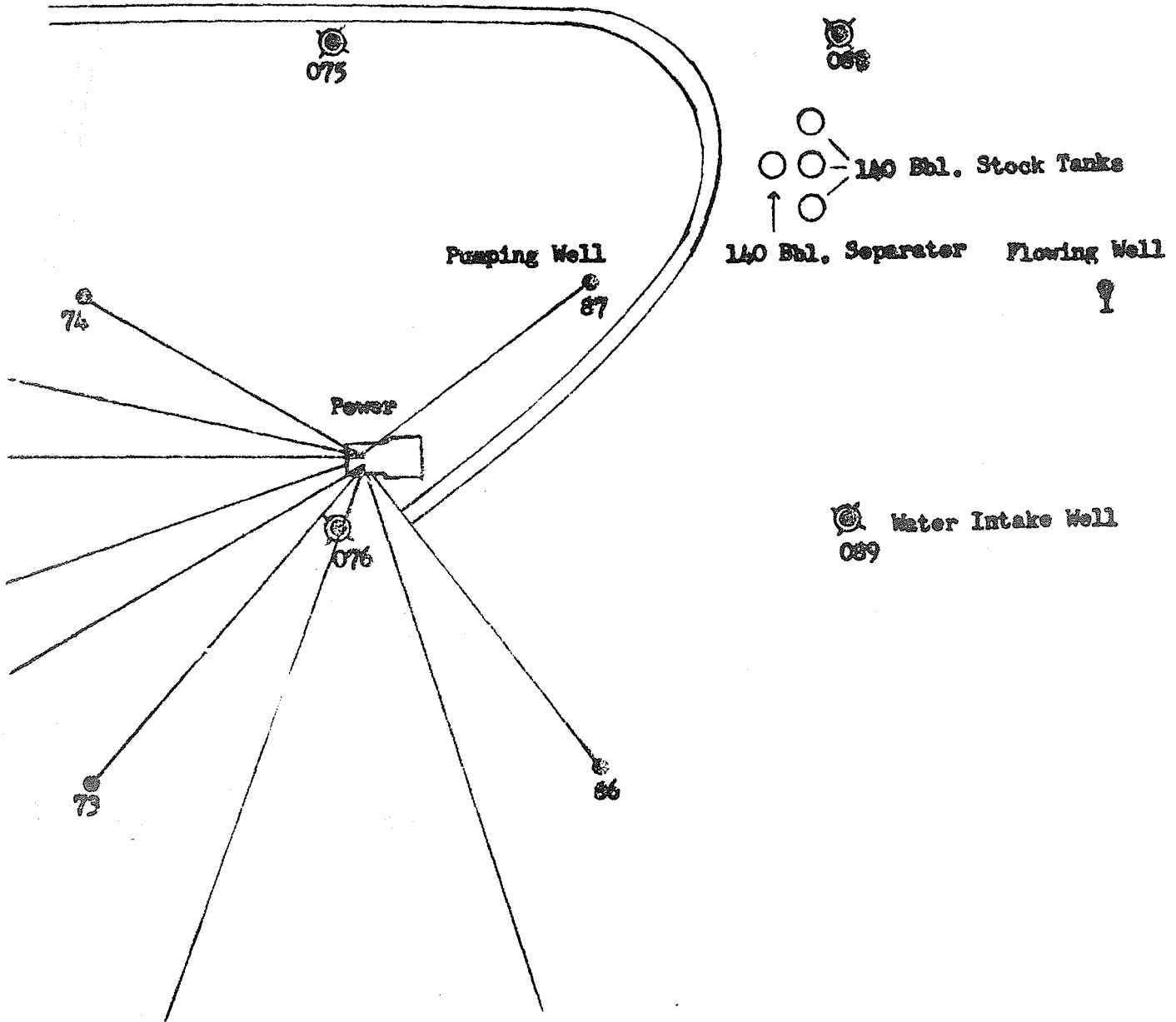

Fig. 7
TRIP D (Step 2) - Oil Well Pumping and Stock Tanks
Scale 1" = 100'

INDEX

- 0.0 8:30 A.M. Leave Wellsville Rod & Gun Club, proceed west on black top road, cross bridge over Genesee River and Railroad tracks.
- 0.15 Turn right (north) on County Route #44.
- 0.85 Sinclair Refinery on right.
- 1.45 Stop light, straight ahead.
- 1.65 Stop light, straight ahead.
- 2.05 Turn right (north) at end of street.
- 2.30 Turn right (north) on Highland Avenue.
- 2.65 Turn left (west) on Route 17 at Airport.
- 3.85 Leave the thick Pleistocene deposits of the Genesee River Valley and continue on the Wellsville geological unit.
- 6.05 Sta. 9. Slow down Whitesville (?) exposed in road cut, showing a storm roller zone, and a fine example of cyclic bedding.
- 7.95 On left (south), Sinclair Refining gathering tanks and pump station, entering the Allegany Oil field.
- 9.55 Allentown, N. Y., caution light near school. NOTE: Oil jacks in front yards and next to store.
- 10.60 Messer Oil Co. Lease, with water treatment plant on right and power house on left.
- 11.10 Oil tank battery on right (north) side of Route #17.
- 11.70 Sta. 10. Slow down Whitesville (?) exposed with fossils on road cut on right (north) side of road.
- 12.00 Electric jack and Whitesville (?) on left (south) side of Route #17.
- 16.10 Stop light at Bolivar, N. Y. turn right (north) on Route #275.
- 16.55 Turn left (west) on Salt Rising black top road (County road #5A).
- 17.00 Pressure plant on left.
- 19.20 Turn right (north) on County road #5.
- 19.55 Siltstone outcropping alongside of road.
- 21.50 Western edge of Allegany Oil field.
- 22.60 Turn left (south) onto State Route #305 black top. Village of Obi.
- 23.10 Water plant on right.
- 24.70 Turn right (west), dirt road.
- 24.85 Cross over Dodge Creek bridge. Glacial delta and river terraces in the valley.
- 25.35 Turn right (north) on Wolf Creek dirt road.
- 27.20 Entrance to Wolf Creek Scout Camp. NOTE: On left, stream or lake deposited dirty outwash material in the glacial deposits.
- 27.60 9:26 A.M. STOP NO. 1 (Sta. 11 on Map 2)

This is a 75 minute stop including loading and unloading.

Wolf Creek flat pebbly conglomerates in abandoned quarry on hill to right. The type locality of Wolf Creek conglomerate is at Sta. 12, $2\frac{1}{2}$ miles to the north and on left side of road. The Wolf Creek conglomerates are characterized by flat or discoidal quartz pebbles accompanied by occasional red jasper pebbles. This quarry was opened about 10 years ago for rip rap to be used for levee dikes along the Allegheny River at Portville, N. Y.

Description:

Top - 3' olive gray micaceous siltstone

4' massive sandstone with a little conglomerate, generally white with some limonitic stain; fossiliferous

3' white 2" to 6" sandstone; fossiliferous

12' massive sandstone and conglomerate containing "Orthoceras" sp., generally white with slight limonitic stain

base - 7' massive white sandstone with a little conglomerate, showing slight limonitic stain (loose slabs contain crinoid stems, arms and calyx plates, "Orthoceras" Palaenatina sp., Modiola sp., Ptychopteria (?) sp. and plant stems, all of which are usually replaced by limonite)

NOTE: From quarry you can see a glacial moraine dam and post glacial stream running from Scout Camp Lake through moraine on west side of valley.

- 27.80 10:41 A.M. Continue trip.
- 28.40 Entrance to Wolf Creek Scout Camp.
- 30.35 Turn left (east) on dirt road.
- 30.85 Narrow bridge over Dodge Creek.
- 31.00 Turn right (west) on Route #305.
- 32.65 Allegheny-Cattaraugus County line.
- 32.90 Bedford Corners straight ahead.
- 34.85 Pennsylvania Railroad crossing on Brooklyn Street, Portville, N. Y.
- 35.10 Brooklyn Street and Route #17 meet, turn right (northwest).
- 35.35 Stop light at Portville, N. Y., continue on Route #17 into Olean, N. Y. Flood control dike along Allegheny River on left (south) of Route #17.
- 36.95 To the right, pit in deltaic sands and silts. It might possibly be delta of Haskell Creek into Allegheny River valley during a glacial lake stage.
- 39.95 Olean Tile Co. to the left (south), just inside City of Olean.
- NOTE: Rest room facilities available in Olean; facilities at Rock City stop very crude.
- 40.50 Stop light at King Street and E. State Street - straight ahead.
- 41.05 Stop light, near Bradners Stadium, straight ahead.
- 41.30 Bridge over Olean Creek and old Barge Canal, straight ahead.
- 41.45 Turn left (south) on South Clinton St., leaving Route #17 (E. State St.).
- 41.80 Turn right (west) at dead end at Beverage Bldg. onto Green Street.
- 41.95 Turn left (south) at stop light onto Route 16A (So. Union St.).
- 42.15 Bridge over Allegheny River.
- 42.30 Stop light, continue straight ahead. On right (west) is cemetery on glacial hill.
- 43.05 New road construction work, continue uphill on Route 16A.
- 44.95 Bear right and follow Route 16A.
- 45.55 Temp. sta. for Cattaraugus and Oswayo.
- 45.90 Entering northern extension of Bradford Oil Field into New York State.
- NOTE: Boulders of Olean cgl. along both sides of road.
- 46.55 Rock City Park entrance.
- 48.75 Post Office at Village of Knapp Creek, N. Y.
- 50.05 New York-Pennsylvania State line.
- 50.80 Oswayo outcrop on left (east) side of road.
- 51.05 11:24 A.M. STOP NO. 2 Cattaraugus red beds with Oswayo above.
This is a 20 minute stop. (sta. 15 on Map 2)
Description: The Oswayo is composed of greenish-gray sandy shales with interbedded shaly, frequently fossiliferous, sandstone layers. The contact of the Cattaraugus and base of Oswayo is believed to be at the top of the highest red shale found in this section which is overlain by a fine-grained, greenish-gray, sandstone. Cattaraugus. A succession of red shales interbedded with greenish-gray shales and fine-grained, greenish-gray, thin-bedded micaceous and argillaceous sandstones. It contains several well defined flat pebble conglomerate horizons. The Cattaraugus contains excellent cross-bedding and shows shaling out of the sandstones.
- 51.05 11:44 A.M. Leave STOP NO. 2 and continue straight ahead.
- 52.25 Turn around place.
- 57.95 Rock City Park entrance, turn left (west) on dirt road.
Row of crude oil stock tanks on left of dirt road.

- 58.45 12:03 P.M. STOP NO. 3 Rock City Park - type locality of Olean conglomerate.
NOTE: We will be here 2 hours, have lunch, examine outcrop and leave at 2:00 P.M.
Mr. Melborne Cunningham, concessionaire at Rock City Park has made available to us picnic and parking areas. While here, the group will visit the type locality of the Olean conglomerate. (Sta. 16 on Map 2)
Description: The Olean conglomerate type locality is south of Olean, N. Y. at Rock City where it is 64' thick. There is an occasional layer of coarse quartz sandstone present in the conglomerate. Cross-bedding, joint cracks and large rounded or ellipsoidal pebbles are prominent features of the Olean conglomerate. The greater majority of the pebbles are vein quartz and milky in color but a few rose-colored ones are present. Pebbles 30 millimeters long are common but most range from 10 to 20 millimeters in length. There are a few pebbles of dark gray slate in the conglomerate. The Olean loses its conglomerate character as it is traced south into Pennsylvania. Fifteen to 20 miles south of the New York-Pennsylvania line it consists of a medium to coarse-grained quartz sandstone. The Olean conglomerate is found as far east as Alma Hill in Allegany County.
- 58.95 2:05 P.M. Leave entrance to Rock City Park. From hill is a good view of Olean and the former Socony-Vacuum Refining stock tank farm.
- 64.05 At corner of Clinton and E. State, heading east on Route #17.
- 70.15 At stop light in Portville, N. Y., head east on Route #17.
- 72.20 Bear left on Route #17 at intersection.
- 76.20 Village of Ceres.
- 81.70 Entering Allegany Oil field.
- 82.60 Old Bolivar Refinery to the left (west) of the road.
- 84.25 Stop light at Bolivar, turn right (east) and follow Route #17.
- 98.60 3:20 P.M. Arrive in Wellsville.

XI - ACKNOWLEDGMENTS

We wish to express our sincere thanks and appreciation to all who have contributed time and effort to the compilation of this guidebook and to all who have assisted in helping us carry out our program. Special mention should be made to Dr. John G. Woodruff and Dr. Irving H. Tesmer who generously gave their time in locating and measuring geological outcrops in the Wellsville area.

Our financial sponsors who have so generously agreed to jointly underwrite the deficit which will no doubt arise when the chips are cleared away are:

Bradley Producing Corporation
D. Y. M. Corporation
Ebenezer Oil Company
Empire Gas & Fuel Company, Limited
New York State Natural Gas Corporation
Richardson Petroleum Company
Sinclair Refining Company
Thornton Company

In addition we wish to mention those who aided us in making the program run smoothly such as the foremen, field men, guides and all who served on our "panel of experts".

Topographic maps traversed during the field trips include the following quadrangles: Wellsville, Belmont, Olean, Salamanca, N. Y. and Bradford, Genesee and Gaines, Pennsylvania.

Topographic maps mentioned in the glacial geology chapter are: Angelica, Arcade, Belmont, Canaseraga, Franklinville, Greenwood, Hornell, Nunda, Olean, Portage and Wellsville quadrangles.

References:

- ASHLEY, G. H., 1935, Studies in Appalachian Mountain Sculpture, Geol. Soc. America Bull. 46, pp. 1395-1436.
- BRYANT, J. C., 1955, A Refinement of the Upland Glacial Drift Border in Southern Cattaraugus County, New York. M. S. Thesis, Cornell University.
- BUTTS, CHAS., 1903, Fossil Faunas of the Olean Quadrangle, N. Y. S. Mus. Bull. 69, pp. 990-999.
- CAMPBELL, M. R., 1903, Geographic Development of Northern Pennsylvania and Southern New York, Geol. Soc. America Bull. 14, pp. 277-296.
- CARLL, J. F., 1883, A Discussion of the Preglacial and Postglacial Drainage in Northwest Pennsylvania and Southwest New York, Second Penn. Geol. Survey, Report III.
- CASTER, K. E., 1934, The Stratigraphy and Paleontology of Northwestern Pennsylvania, Part I, Stratigraphy, Bull. Amer. Paleont. Vol. 21, No. 71, 185 p.
- CHADWICK, G. H. and E. U. Dunbar 1924, Genesee Glacial Lakes, Geol. Soc. America Bull. 35, pp. 669-676.
- _____, 1933, Great Catskill Delta, and Revision of Late Devonian Succession, Pan-Am. Geologist, Vol. 60, No. 2, pp. 91-107; No. 3, 189-204; No. 4, 275-286, No. 5, 348-360.
- _____, 1935, Faunal Differentiation in the Upper Devonian, Geol. Soc. America Bull. Vol. 46, No. 2; pp 305-342.
- _____, 1935, Chemung in Portage, Geol. Soc. America Bull. Vol. 46, No. 2 pp. 343-354.
- COLE, W. STORRS, 1938, Erosion Surfaces of Western and Central New York, Jour. Geol. 46, pp. 191-206.
- COOPER, G. A., et al, 1942, Correlation of the Devonian Sedimentary Formations of North America, Geol. Soc. America Bull. Vol. 53, pp. 1729-1794.
- DENNY, C. S., 1956-a, Wisconsin Drifts in the Elmira Region, New York and Their Possible Equivalents in New England, Am. Jour. Sci. 254, pp. 82-95.
- _____, 1956-b, Surficial Geology and Geomorphology of Potter County, Pennsylvania, U. S. Geol. Survey Prof. Paper 288, 72 p.
- DUNBAR, E. U., 1923, Glacial Lake Succession in the Genesee Valley, M. S. Thesis, University of Rochester.
- FAIRCHILD, H. L., 1928, Geologic Story of the Genesee Valley and Western New York, Rochester, 215 p.
- _____, 1932-a, New York Moraines, Geol. Soc. America Bull. 43, pp. 627-662.
- _____, 1932-b, New York Physiography and Glaciology West of the Genesee Valley, Proc. Rochester Acad. Sci. 7, pp. 97-135.
- FETTKE, CHAS. R., 1938, The Bradford Oil Field, Pennsylvania and New York, Pa. Geol. Surv. Bull. M21 454 p.
- _____, 1948, Subsurface Trenton and Sub-Trenton Rocks in Ohio, New York, Pennsylvania, and West Virginia; American Association of Petroleum Geologists Vol. 32, No. 8. (1948), pp. 1457-1492
- FINN, F. H. Geology and Occurrence of Natural Gas in Oriskany Sandstone in Pennsylvania and New York, Bull. Amer. Assoc. of Pet. Geol. Vol. 33, No. 3, March 1949
- FLINT, R. F., 1953, Probable Wisconsin Substages and Late Wisconsin Events in Northeastern United States and Southeastern Canada, Geol. Soc. America Bull. 64, pp. 897-920

- _____, and Meyer Rubin, 1955, Radiocarbon Dates of pre-Mankato Events in Eastern and Central North America, *Science*, 121, pp. 649-658.
- GLENN, L. C., 1903, Devonian and Carbonic Formations of Southwestern New York, N. Y. S. Mus. Bull. 69, pp. 967-989.
- GRABAU, A. W., 1894, The pre-Glacial Channel of Genesee River, *Proc. Boston Soc., Nat. Hist.* 26, pp. 359-369.
- HERRICK, JOHN P., 1949, Empire Oil, Dodd Mead & Co.
- HORBERG, LELAND, 1955, Radiocarbon Dates and Pleistocene Chronological Problems in the Mississippi Valley Region, *Jour. Geol.* 63, pp. 278-286.
- KAY, G. MARSHALL. 1942. Northern Allegany Synclinorium, *Geol. Soc. Amer. Bul.* 53: 1600-57.
- KREIDLER, W. LYNN, 1953, History, Geology and Future Possibilities of Gas and Oil in New York State, N. Y. S. Mus. Circ. 33, 58 p.
- LEVERETT, FRANK, 1902, Glacial Formations and Drainage Features of the Erie and Ohio Basins, U. S. Geol. Survey Monograph 41, 802 p.
- _____, 1934, Glacial Deposits in Pennsylvania Outside the Wisconsin Terminal Moraine, *Penn. Geol. Survey, 4th Series, Bull.* G7, 123 p.
- LOBECK, A. K., 1927, Popular Guide to the Geology and Physiography of Allegany State Park, N. Y. State Museum Handbook 1, 288 p.
- MacCLINTOCK, PAUL 1954, Leaching of Wisconsin Glacial Gravels in Eastern North America, *Geol. Soc. America Bull.* 65, pp. 369-384.
- _____, and E. T. Apfel 1944, Correlation of the Drifts of the Salamanca Re-entrant, New York, *Geol. Soc. America Bull.* 55, pp. 1143-1164.
- PEPPER, J., and DeWitt, W., 1951, Stratigraphy of the Late Devonian Perrysburg Formation in Western and West-Central New York, U. S. Geol. Surv. Oil and Gas Investigation Chart OC-45.
- SECONDARY RECOVERY OF OIL IN THE U. S., Second Edition, Division of Production, Amer. Pet. Inst. 1950, 838 p.
- SMITH, H.T.U. 1953, Periglacial Frost Wedging in the Rock Cities of Southwestern New York, *Geol. Soc. America Bull.* 64, p. 1474.
- SPENCER, O. F., Secondary Recovery of Oil, Mineral Industries Extension Service, The Pennsylvania State Univ. 1949.
- SUESS, H. E., 1954, U. S. Geological Survey Radiocarbon Date I, *Science*, 120, pp. 467-474.
- SWARTZ, FRANK M., 1948; Trenton and Sub-Trenton in New York, Pennsylvania, and Maryland; American Association of Petroleum Geologists Vol. 32, No. 8 (August, 1948), pp. 1493-1595.
- SWEENEY, ALBERT E., Jr., Interstate Oil Compact Commission, Various Papers on Status of Secondary Recovery in U. S., ie, *Oil & Gas Journal* 3/23/57, p. 73
- TESMER, I. H., 1955, Restudy of Upper Devonian (Chautauquan) Stratigraphy and Paleontology in Southwestern New York State, N. Y. S. Mus. Circ. 42, 22 p.
- VER STEEG, KARL 1932, Erosion Surfaces of Appalachian Plateau, *Pan-Amer. Geol.* 58, pp. 31-44
- VON ENGELN, O. D. 1937, Rock Sculpture by Glaciers; A Review, *Geog. Review*, 27, pp. 478-482.
- WEDEL, A. A., 1932, Geologic Structure of the Devonian Strata of South-Central N. Y., N. Y. S. Mus. Bull. 294, 74 p.
- WILLARD, B. 1939, The Devonian of Pennsylvania, *Pa. Geol. Surv. Bull.* G19, 481 p.
- WOOD, A. E. 1948; Glacial Stream Diversion Near Hornell, New York, *Geol. Soc. America Bull.* 59, pp. 1285-1306.
- WOODRUFF, J. G. 1942, Geology of the Wellsville Quadrangle, New York, N. Y. State Mus. Bull. 326, 135 p.
- YOUNG, W. H., Jr. and Holbrook G. W., Water Flooding in the State of New York, Secondary Recovery of Oil in the U. S., Sec. Ed., p. 401 Div. of Production, American Petroleum Institute, 1950.